



Government of Malawi

Rural Water Supply Operation and Maintenance Series 2

Community Based Management (O & M Refresher Course) Tool Kits



Ministry of Agriculture, Irrigation and Water Development

March 2015



Rural Water Supply Operation and Maintenance Series 2

**Community Based Management
(O & M Refresher Course)
Tool Kits**

Ministry of Agriculture, Irrigation and Water Development

March 2015

Ministry of Agriculture, Irrigation and Water Development
Tikwere House,
City Centre,
P/Bag 390,
Lilongwe 3,
Malawi
Telephone No.: (265) 1 770 211 / 770 233 / 770 344 / 770 447
Fax No.: (265) 01 773 737
E-mail: secretary@irriwater.org

Date of publication: March 2015

194p

Rural Water Supply Operation and Maintenance Series 2

This document was published by Ministry of Agriculture, Irrigation and Water Development (MoAIWD) of Malawi with the technical and financial support of the Japan International Cooperation Agency (JICA) through the “Project for Enhancement of Operation and Maintenance for Rural Water Supply in the Republic of Malawi”.

The copyright of this document shall exclusively remain with MoAIWD and JICA (MoAIWD and JICA are hereinafter referred to as the “copyright holders”). The copyright holders allow anyone to use this document as long as it is used for the purpose of public good. Any parts of this document including the illustrations may be copied to meet local needs without permission from the copyright holders, provided that the copies are

- (a) distributed for free and used for the good of people;
- (b) not used for profit making;
- (c) referred with the source of information.

For making any modifications, reprinting and/or using any part of the document for commercial purposes, please ask permission of the copyright holders at the following contacts;

Director of Water Supply Services
Ministry of Agriculture, Irrigation and Water Development

Country Representative of JICA Malawi Office
Telephone No: (265) 01 771 554 / 644 / 945

TABLE OF CONTENTS

PREFACE	iv
ACKNOWLEDGEMENT	v
HOW TO USE THIS TOOL KITS.....	vi
TABLE OF LIST OF TOOLS.....	viii
Tool 1: Pre-survey Form	1
Tool 2: Unserilized Posters on O&M Issues	9
Tool 3: Sample Training Timetable for CBM O&M Refresher Course	21
Tool 4: Tariff Setting Booklet (Afridev Handpump Version)	25
Tool 5: Form of User Contribution Book.....	53
Tool 6: Form of Cash Book	57
Tool 7: Promotion Song for Payment of Water (Water is Life).....	61
Tool 8: Village Head’s Consensus Form for Promotion of Regular Payment of Water Fee	65
Tool 9: Sanitary Inspection Survey Form.....	69
Tool 10: Visual Education Materials.....	73
Tool 11: Informed Choice Booklet for Water Point Sanitation (Afridev Handpump Version)	89
Tool 12: Village Head’s Consensus Form for the Promotion of Water Point Sanitation	115
Tool 13: Promotion Song for Water Point Sanitation (We should not underrate)	119
Tool 14: O&M schedule.....	123
Tool 15: Trouble Shooting Booklet (Afridev Handpump Version)	131
Tool 16: Sample Designs for Security System (Afridev Handpump Version)	147
Tool 17: Sample of Contract between WPC and AM	163
Tool 18: Facility Management Plan Form	167
Tool 19: Action Plan Form	175
Tool 20: WPC Meeting Agenda and Checklist.....	179
Tool 21: Monitoring Form	183

PREFACE

Millions of Malawians, mostly rural, still lack access to clean water and are thus exposed to a number of water and sanitation diseases, such as diarrhoea, cholera, etc. Addressing this issue is a key component of the Malawi Growth and Development Strategy (MGDS). To ensure access to clean safe water in the country, Malawi must build not only the required infrastructure, but also the appropriate institutional systems which can effectively oversee, guide and manage the construction and ongoing operation and maintenance (O&M).

In the past, the Malawi government took full responsibility of the O&M of rural water supply facilities. However, this system was marred by numerous inefficiencies making it unsustainable. Without a strong presence in communities, these water supply facilities would often fall into disrepair, but also experience other issues such as catchment encroachment and vandalism.

In response, the National Decentralization Policy, instated in 1998 by the Malawi Government, emphasizes community empowerment through a transfer of power and responsibility to local authorities. Since then, there has been an increasing emphasis on developing community ownership through the adoption of practices like Community Based Management (CBM) trainings.

The notable challenges lie in accessibility and functionality of the existing water points as well as using them sustainably due to ever increasing demand from the growing population. However, most boreholes break down due to ineffective village level operation and maintenance. Cases of theft and vandalism of boreholes have also been reported due to lack of community ownership and responsibility.

This Community Based Management (O&M Refresher Course) Tool Kits is designed to provide a harmonised approach for carrying out water and sanitation services by various stakeholders to ensure sustainable implementation of water supply services at community level.

It is hoped that all stakeholders use this Tool Kits when implementing community water and sanitation programmes to ensure uniformity of approaches as well as sustainability of old and new water supply facilities and that Malawi can move ahead in providing access to safe water for all Malawians. Any substantive comments for improvement on the manual are welcome and should be directed to the secretary responsible for water development.

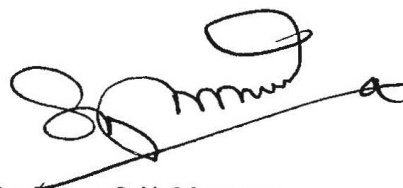

Sandram C. Y. Maweru
SECRETARY FOR IRRIGATION AND WATER DEVELOPMENT

ACKNOWLEDGEMENT

This Tool Kits was produced by the “Project for Enhancement of Operation and Maintenance for Rural Water Supply in the Republic of Malawi” under the technical cooperation by Japan International Cooperation Agency (JICA).

A series of workshops were held in the project, and a lot of stakeholders in Malawi, development partners, and NGOs technically contributed in the formulation of the Tool Kits. The Ministry of Agriculture, Irrigation and Water Development therefore, extends special thanks to these stakeholders for allowing their staff to participate in the production of this Tool Kits.

The Ministry is also indebted to JICA for assisting in the development of the Tool Kits, and many who have not been mentioned here but contributed in different ways.

HOW TO USE THIS TOOL KITS

This **Tool Kits** was developed for District Coordination Teams (DCTs), Extension Workers (EWs) and Water Point Committee (WPC) members to be used during the CBM refresher training so as to help increasing community ownership and responsibility towards water facilities.

For DCT members and EWs, this **Tool Kits** should be used together with the CBM (O&M Refresher Course) Training Manual.

Each module of the manual contains tools as shown in the table below.

CBM (O&M Refresher Course) Training Manual		CBM (O&M Refresher Course) Tool Kits	
Module No.	Module Name	Tool No.	Tool Name
-	Introduction	Tool 1	Pre-survey Form
1	Identifying the O&M issues	Tool 2	Unsterilized Posters on O&M Issues
		Tool 3	Sample Training Time Table
2	Financial Management	Tool 4	Tariff Setting Booklet
		Tool 5	Form of User Contribution Book
		Tool 6	Form of Cask Book
		Tool 7	Promotion Song for Payment of Water (Water is Life)
		Tool 8	Village Head's Consensus Form for the Promotion of Regular Payment of Water
3	Water Point Sanitation and Hygiene	Tool 9	Sanitary Inspection Survey Form
		Tool 10	Visual Education Materials
		Tool 11	Informed Choice Booklet for Water Point Sanitation (Afridev Handpump Version)
		Tool 12	Village Head's Consensus Form for Promotion of Water Point Sanitation

CBM (O&M Refresher Course) Training Manual		CBM (O&M Refresher Course) Tool Kits	
Module No.	Module Name	Tool No.	Tool Name
		Tool 13	Promotion Song for Water Point Sanitation
4	Technical Components	Tool 14	O&M Schedule
		Tool 15	Trouble shooting Booklet (Afridev Handpump Version)
		Tool 16	Sample Design for Security System
5	Roles of Different players	Tool 17	Sample of Contract between WPC and AM
6	Planning for Operation and Maintenance	Tool 18	Facility Management Plan Form
		Tool 19	Action Plan Form
8	Community Mobilization	Tool 20	WPC Meeting Agenda and Checklist
9	Monitoring & Evaluation	Tool 21	Monitoring form

For WPC members, this **Tool Kits** is provided as a stand-alone document to be used and completed during the CBM refresher training and kept by the WPC members to guide their daily water supply and sanitation operations.

Not all tools could be used by WPCs in their operations; as such tools such as the pre-survey form (Tool 1), sample training time table (Tool 3), sanitary inspection form (Tool 9) and monitoring form (Tool 21) may not be used by WPCs.

TABLE OF LIST OF TOOLS

TEBULO LA MNDANDANDA WA ZIDA

Tool No.	Dzina La Chida
Tool 1	Fomu ya kafukufuku woyamba
Tool 2	Zithunzi zowonetsazinthu zosiyanasiyana pa nkhani ya kayendetsedwe ndi kakonzedwe ka mjigo.
Tool 3	Chitsanzo cha ndondomeko ya maphunziro achibwereza kwa komiti ya madzi
Tool 4	Buku la mmene mungakhazikitsire mtengo wosonkha
Tool 5	Buku la kaundula wansonkhansonkha
Tool 6	Buku la la ndalama zonse (Kashi Book).
Tool 7	Nyimbo yolimbikitsa kusonkha ndalama za mjigo.
Tool 8	Fomu ya chitsimikizo cha mfumu yolimbikitsa kulipira ndalama za pa Mjigo.
Tool 9	Fomu ya kuuniunni wa ukhondo pa Mjigo.
Tool 10	Zithunzi zophunzitsira
Tool 11	Buku lothandiza kusonkha mmene tingachitire ukhondo pa Mjigo wa Afridevu.
Tool 12	Fomu ya chitsimikizo cha mfumu yolimbikitsa ukhondo wa pamjigo.
Tool 13	Nyimbo yolimbikitsa ukhondo wa pa Mjigo.
Tool 14	Mndandanda wa mmene tiziyendetsera ndi kukonzamjigo wathu
Tool 15	Buku la kakonzedwe ka Mjigo wa Afridev.
Tool 16	Chitsanzo cha kakonzedwe ka loko wothandiza kuti zipangizo za Mjigo wa Afridev zisabedwe.
Tool 17	Chitsanzo cha mgwirizano pakati pa akomiti ya mjigo ndi Amakaniki
Tool 18	Ndondomeko ya mmene tizisamalira Mjigo wathu.
Tool 19	Ndondomeko ya zomwe tichite potukula Mjigo wathu.
Tool 20	Mitu ya zokambirana ndi mfundo zomwe zamangidwa
Tool 21	Fomu ya kalondolondo

Tool 1

Pre-survey Form

Fomu ya mafunso a kafukufuku woyamba

Pre-Survey Form

Tsiku/Nthawi: _____ Nyengo: _____ Dzina la opanga kafukufuku _____
 Temp. Site No.: _____ (GPS S/N: _____)

TA:	Chipatala:	Mlangizi/ Udindo:
-----	------------	-------------------

Onani izi musanayambe kufunsa mafunso

Ndongomeko yoyenera kutsatira posankha midzi ya chitsanzo	Zotsatira
a. Kodi m' mudzi muno muli mjigo?	<input type="checkbox"/> Eya <input type="checkbox"/> Ayi
b. Kodi mjigo unakumbidwa ndi bungwe lanji?	
c. Kodi mjigo umenewo uli ndi zipangizo za Afridevu? (Ngati ayi, ndi za mtundu wanji? _____)	<input type="checkbox"/> Eya <input type="checkbox"/> Ayi
d. Kodi mjigowu unakumbidwa liti?	
e. Kodi mjigo wanu unakumanapo ndi vuto monga kubedwa kwa zipangizo zina komanso kusiyidwa osagwiritsanso ntchito?	<input type="checkbox"/> Eya <input type="checkbox"/> Ayi
f. Kodi munakhazikitsa komiti ya madzi mudzi muno?	<input type="checkbox"/> Eya <input type="checkbox"/> Ayi
g. Kodi komiti imeneyi inaphunzitsidwa mamphunziro a CBM?	<input type="checkbox"/> Eya <input type="checkbox"/> Ayi
Mfundo zina zofunikira:	

1. Malo

Zoyenera kufufuza	Zotsatira
Dzina la a Gulupu	
Dzina la mudzi	
Malo enieni komwe mudzi uli (site) Dzina / Nambala:	
Kalozero wa malo omwe muli (GPS Coordinates)	Kumwera
	Kumvuma
Mtunda woyerekeza kufika ku Mchinji Boma (Kupita kokha)	
Nseu m'mene ulili (Ndiwodutsika)	
Nthawi yoyerekeza imene ingakwanire kuchokera ku Mchinji Boma (_____)	

	<p>Mtundu: <input type="checkbox"/>Longokumba <input type="checkbox"/>Lokumba komanso lokhala ndi chivindikiliro <input type="checkbox"/>Dzenje lotetezedwa lokhala ndi chovindikira <input type="checkbox"/>Dzenje loikidwa miyala mkati <input type="checkbox"/>Dzenje lotetezedwa komanso lokhala ndi miyala mkati <input type="checkbox"/>Dzenje lokhala ndi ngalande yodutsiramo madzi <input type="checkbox"/>Dzenje lokhala ndi munda kumapeto <input type="checkbox"/></p> <p>Mitundu ina ()</p> <p><input type="checkbox"/>Likugwira ntchito <input type="checkbox"/>Silikugwira ntchito</p> <p>Ndichifukwa chiyani silikugwira ntchito:</p>
Mpanda	<p><input type="checkbox"/>Unamangidwa <input type="checkbox"/>Sunamangidwe</p> <p><input type="checkbox"/>Unagumuka <input type="checkbox"/>Ukumangidwa pano</p> <p>Mtundu: <input type="checkbox"/>Wa udzu <input type="checkbox"/>Wa matabwa <input type="checkbox"/>Wa nsungwi <input type="checkbox"/>Wazomela/maluwa <input type="checkbox"/>Wa njerwa <input type="checkbox"/>Wa njerwa komanso uli ndi pulasitala</p> <p><input type="checkbox"/>Mitundu ina ()</p>
Ndi zinthu ziti zomwe zili malipande osaposera makumi atatu ndi pomwe pali mjigo zomwe zingapangitse madzi kukhala owonongeka/ oipa?	<p><input type="checkbox"/>Palibe <input type="checkbox"/>Chimbudzi <input type="checkbox"/>Nkhuti <input type="checkbox"/>Kholo la ziweto</p> <p><input type="checkbox"/>Munda <input type="checkbox"/>Bafa <input type="checkbox"/>Manda <input type="checkbox"/>Zithapwi zomwe zili ndi madzi osayenda</p> <p><input type="checkbox"/>Zina ()</p>
Malo ozungulira pa mjigo	<p><input type="checkbox"/>Aukhondo <input type="checkbox"/>A umve</p>

4. Mmene komiti ya Madzi ilili pakadali pano

Zofunika kufufuza		Zotsatira	
Chaka chomwe komitiyi inakhazikitsidwa			
Anthu omwe ali mu komitiyi	Nambala ya anthu onse akomiti?	Amuna: _____ Akazi: _____ Nambala yonse: _____	
	Wapampando (M / F)	Dzina:	Nambala ya Lamya.:
	Wachiwiri kwa Wapampando (M / F)	Dzina:	Nambala ya Lamya.:
	Mlembi (M / F)	Dzina:	Nambala ya Lamya.:
	Wachiwiri kwa Mlembi (M / F)	Dzina:	Nambala ya Lamya.:
	Msungichuma(M / F)	Dzina:	Nambala ya Lamya.:
	Wachiwiri kwa Msungi chuma (M / F)	Dzina:	Nambala ya Lamya.:
	Othandizira kukonza Mjigo 1 (M / F)	Dzina:	Nambala ya Lamya.:
	Othandizira kukonza Mjigo2 (M / F)	Dzina:	Nambala ya Lamya.:
	Othandizira kukonza Mjigo3 (M / F)	Dzina:	Nambala ya Lamya.:

	Dzina: Nambala ya Lamy.: Dzina: Nambala ya Lamy.: Dzina: Nambala ya Lamy.:
Kodi komiti yamadzi ikugwira ntchito	<input type="checkbox"/> Eya <input type="checkbox"/> Ayi (Chifukwa:)
Ndi mabanja angati omwe akugwiritsa ntchito Mjigo	Mabanja ()
Kodi buku la mapulani akayendetsedwe ndi kakonzedwe ka mjigo lilipo	<input type="checkbox"/> FMP <input type="checkbox"/> O&M Plan <input type="checkbox"/> Palibe
Kodi pali ndondomeko yomwe imatsatidwa pofuna kusamala mjigo monga kusesa, kukapa madzi mu dzenje la pa mjigo ndi kukonza mwina ndi mwina momwe mofuna kukonzedwa pa mjigo ?	<input type="checkbox"/> Eya <input type="checkbox"/> Ayi
Kodi ndalama ya pa mjigo imatoleledwa?	<input type="checkbox"/> Eya <input type="checkbox"/> Ayi
Kodi ndalamayi imaperekedwa motani	<input type="checkbox"/> Pamene mjigo wawonongeka ndipo ukufuna kukonzedwa <input type="checkbox"/> Mwezi ndi mwezi or pa chaka kamodzi(MK /Pabanja/M or Y) <input type="checkbox"/> Maganyu(Masiku/Chaka) <input type="checkbox"/> Njira zina ()
Ngati ndalama ya madzi imatoleledwa, kodi muli ndi tsiku lokhazikika limene mumatolera ndalamayi?	<input type="checkbox"/> Eya <input type="checkbox"/> Ayi
Nambala ya ma banja omwe amapereka ndalama ya madzi.	(Pabanja) and/or (Kuyelekeza. Pelesenti Pabanja)
Ndalama zomwe zimaperekedwa pa banja lililonse ndi zingati?	MK/Pabanja
Ndalama zomwe zili ku thumba pakali pano (MK)	MK
Zipangizo zimene ziliko (Maina ake azipangizozo)	
Malo otetezeka omwe angasungile ndalama	<input type="checkbox"/> Msungi chuma (Mudzi) <input type="checkbox"/> Banki (Dzina:) <input type="checkbox"/> Positi ofesi <input type="checkbox"/> Malo ena()
Buku lolemba mmene ndalama zikuyendera lilipo?	<input type="checkbox"/> Eya <input type="checkbox"/> Ayi
Kodi akomiti amene amakokonza mjigo amayendera mjigo komanso malo ozungulira mjigo mowirikiza bwanji? ?	<input type="checkbox"/> Eya, <input type="checkbox"/> Ayi (a) Kukonza usanawonongeke; ➤ Zowona pa mulungu: ✓ Kuwona kuti manati ndi ma bauti ali omangitsa ✓ Kuwona kuti fakalamu pini ndi hang'ala, ma nati ali omangitsa ➤ Zowona pa mwezi: ✓ Kuwona ngati zipangizo zina mu mutu wa pampu zilipo ✓ Kuwona ngati mjigo pakumveka phokosos lachilendo ✓ Kuwona ngati nthuthu la pampu likugwewera ✓ Kuwona ngati pampu ikutaya madzi (b) Kukonza zinthu zomwe zawonongeka pa pampu; ✓ Kuwona ngati silabu ya pa pampu pali ming'alu

	<p>ndikukonzaKukwirira khuti zomwe madzi amadekhamo ndi dothi.</p> <ul style="list-style-type: none"> ✓ Kumanga mpanda malo ozungulira mjigo kuti ziweto zisamalowetso ✓ Kusamalira malo amjigo nthawi zonse kuti aziwoneka abwino ✓ Kudziwitsa anthu ogwiritsa ntchito mjigo kuti umagwira bwanji ndiponso kuti pazikhala pa ukhondo.
Kodi mukumudziwa okonza mijigo mudera lanuli?	<input type="checkbox"/> Eya, Ngati mukumudziwa dzina lake ndi ndani?: _____ <input type="checkbox"/> Ayi
Kodi sitolo yomwe amagulitsamo zipangizo za mjigo mukuyidziwa?	<input type="checkbox"/> Eya, Dzina la sitolo ndi malo enieni omwe sitoloyi ikupezeka <input type="checkbox"/> Ayi

Kumbukirani kujambula Zithunzi izi mutayima m'malo alozera m'musimuwa

- 1. Tengani Zinthunzi m'malo oyenera (Imani mmalo omwe awonetsera pa chithunzi chotsatirachi.
- 2. Chithunzi chowonetsa kuti Mjigo ukutulutsa madzi (Jambulani pamene madzi ukutuluka)
- 3.Dzenje lotayikira Madzi
- 4. Mpanda
- 5. Zinthu zomwe zingapangitse madzi kuwonongeka (ngati zilipo, monga ; Chimbuzi, Dzenje lotaya zinyalala , Khola la ziweto, Bafa, Munda, Manda, ndi Zina.)
- 6. Ndondomeko ya kasamalidwe ndi kakonzedwe ka Mjigo, Buku la msonkhamsonkha, Kashi Buku, Ma lisiti azogula
- 7. Zina (Monga mbali ya mjigo yowonongeka ngati konkiriti ndi zina.)

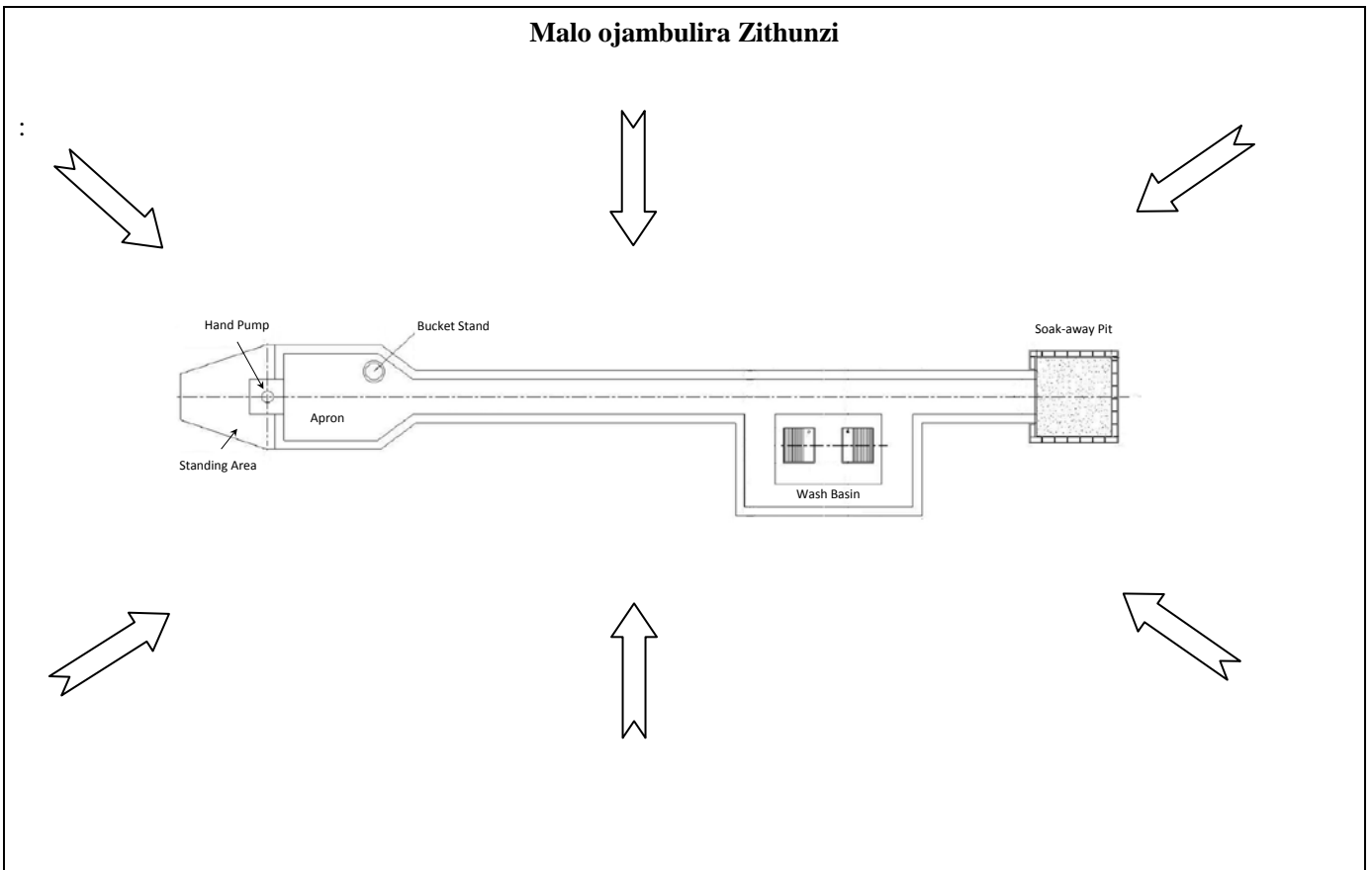

Chithunzi cha pansi cha Mjigo(Kuwonetsa mtunda wa malo amene muli zinthu zomwe zingachititse madzi apa Mjigo kuwonongeka)

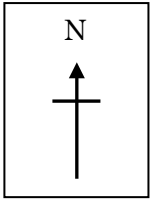

Tool 2

Unserilized Posters on O&M Issues

Zithunzi zowonetsa zochitika zosiyanasiyana pa nkhani ya kayendetsedwe ndi kakonzedwe ka mijigo

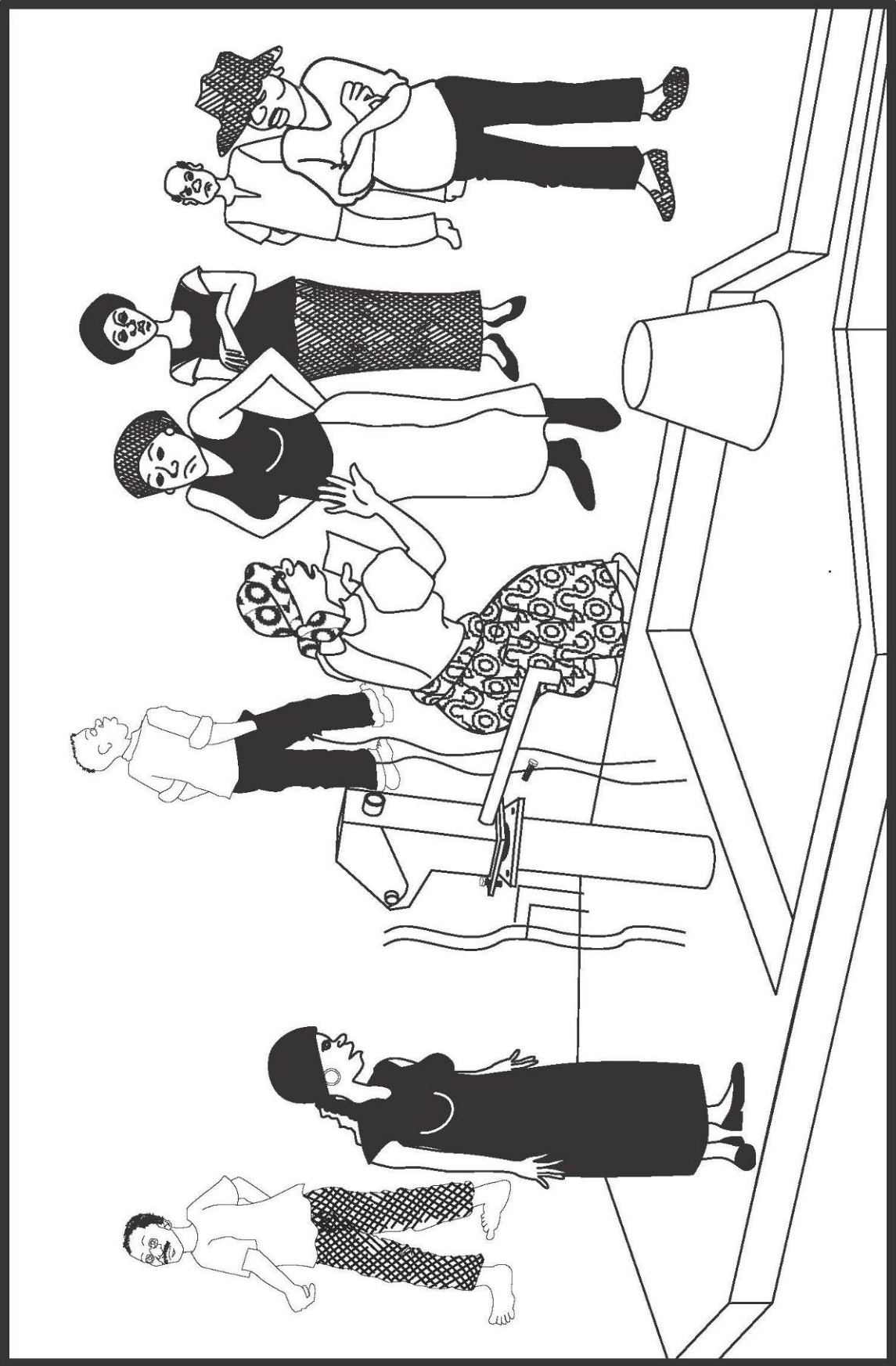

Anthu akukana kupeleka ndalama zokonzera mjigo

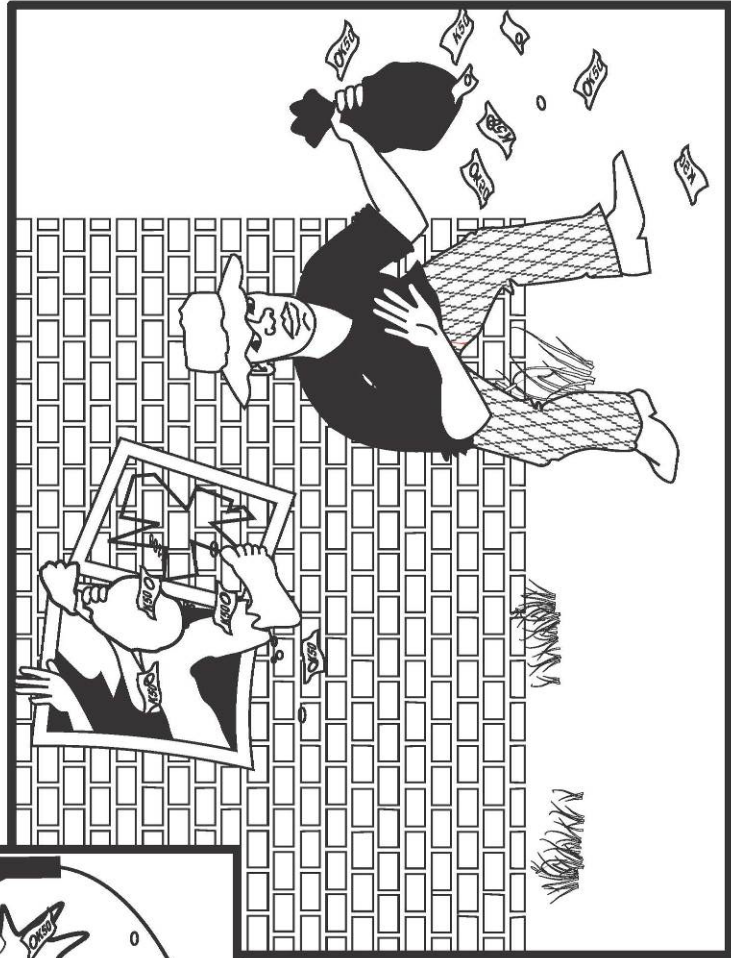
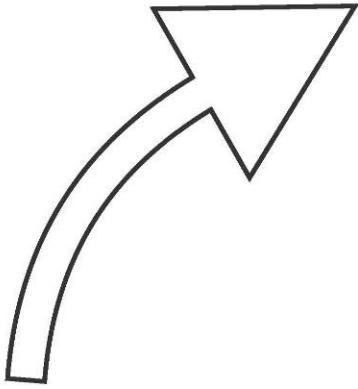
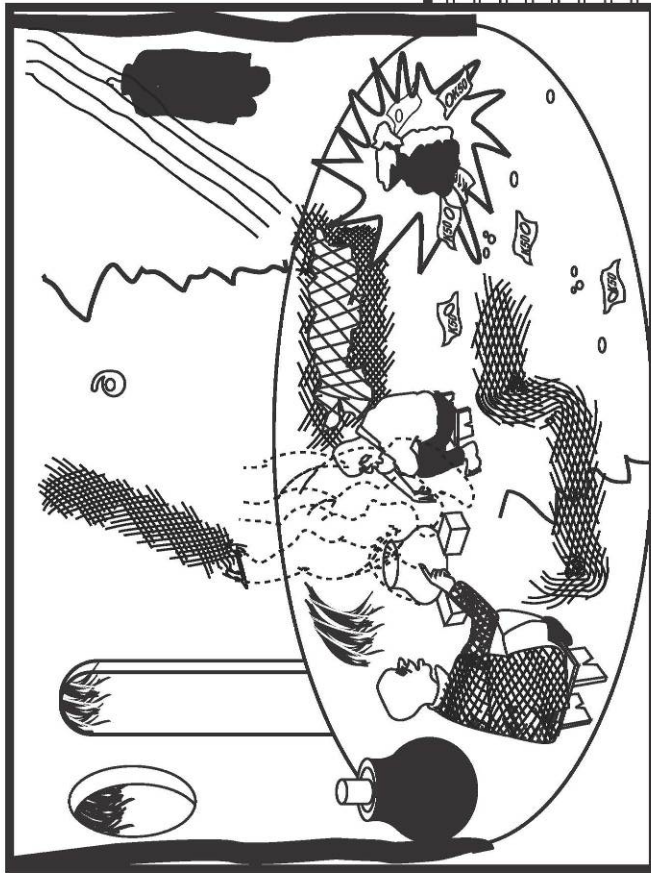

Ndalama za Mjigo zabadwa chifukwa chosowa chitetezo chokwanira

X

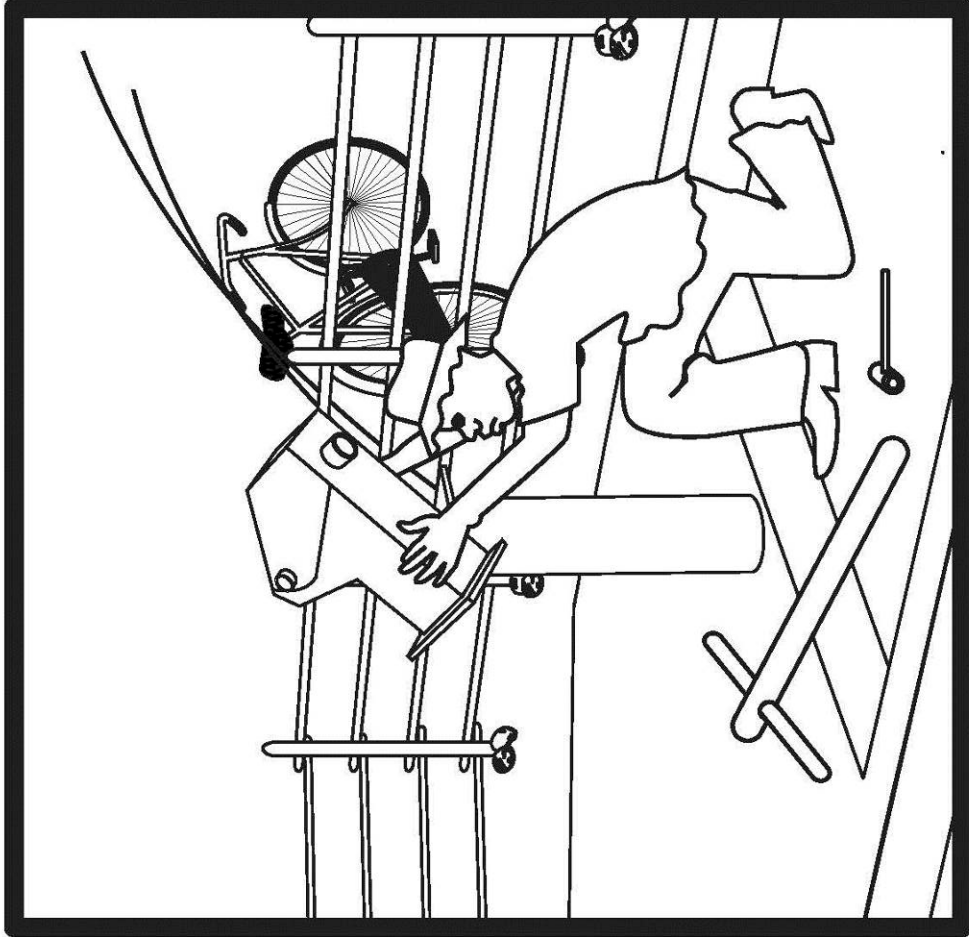

✓

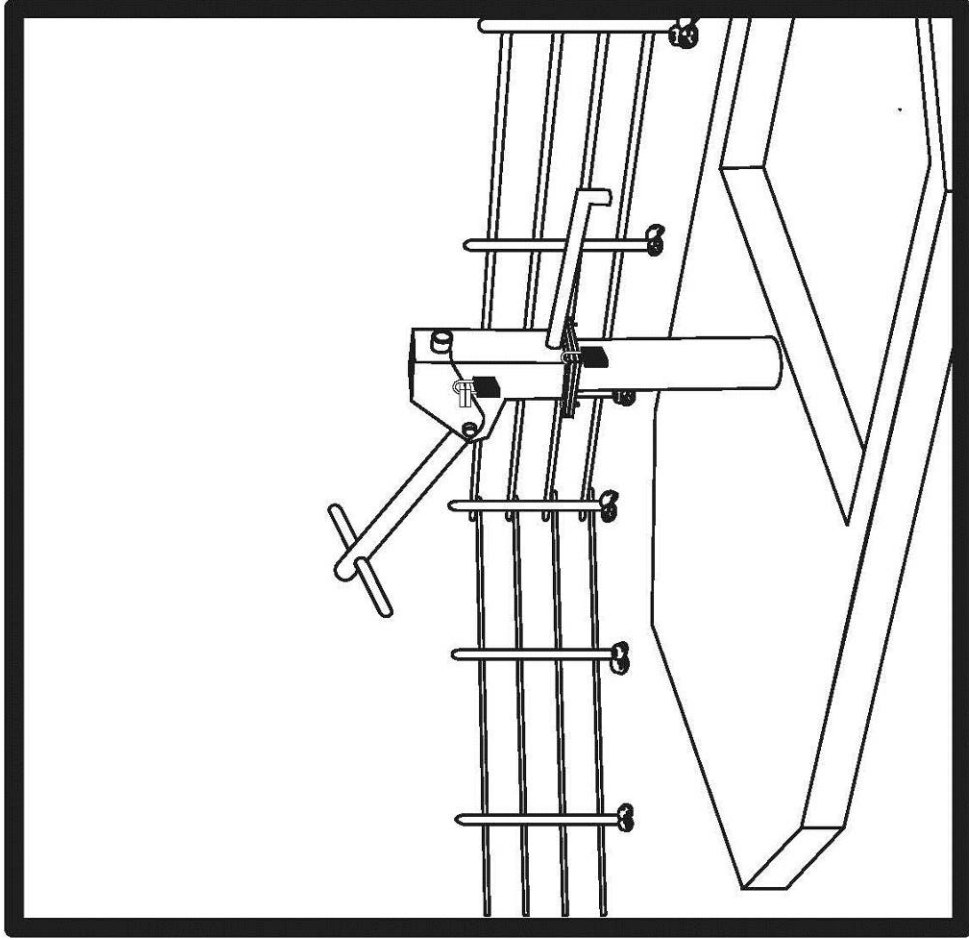

Mjigo wopanda chitetezo

Mjigo uli ndi chitetezo

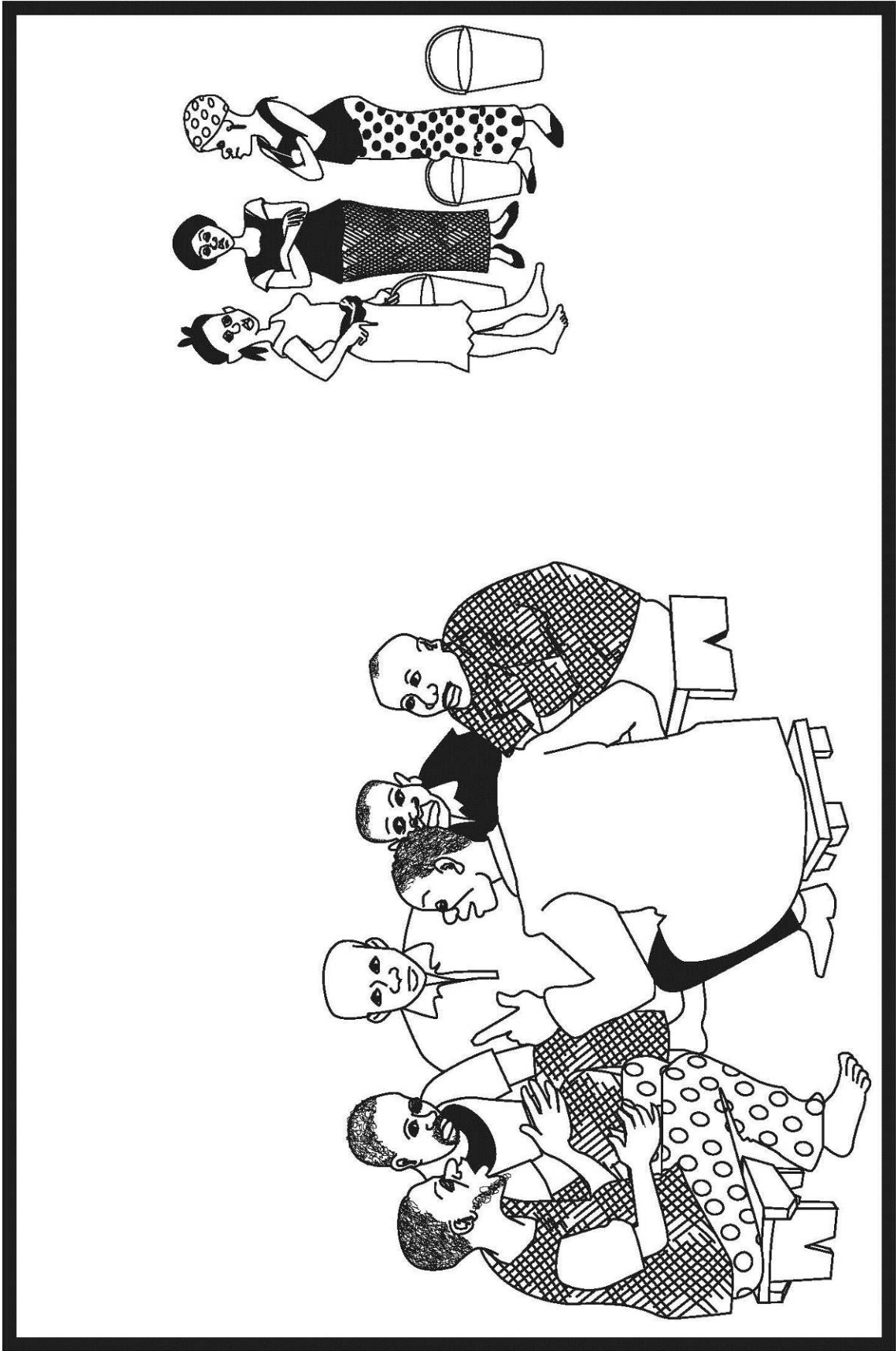

Amayi sanapatsidwe mwayi wopereka maganizo awo pa nkhani yokhuza madzi

X



✓

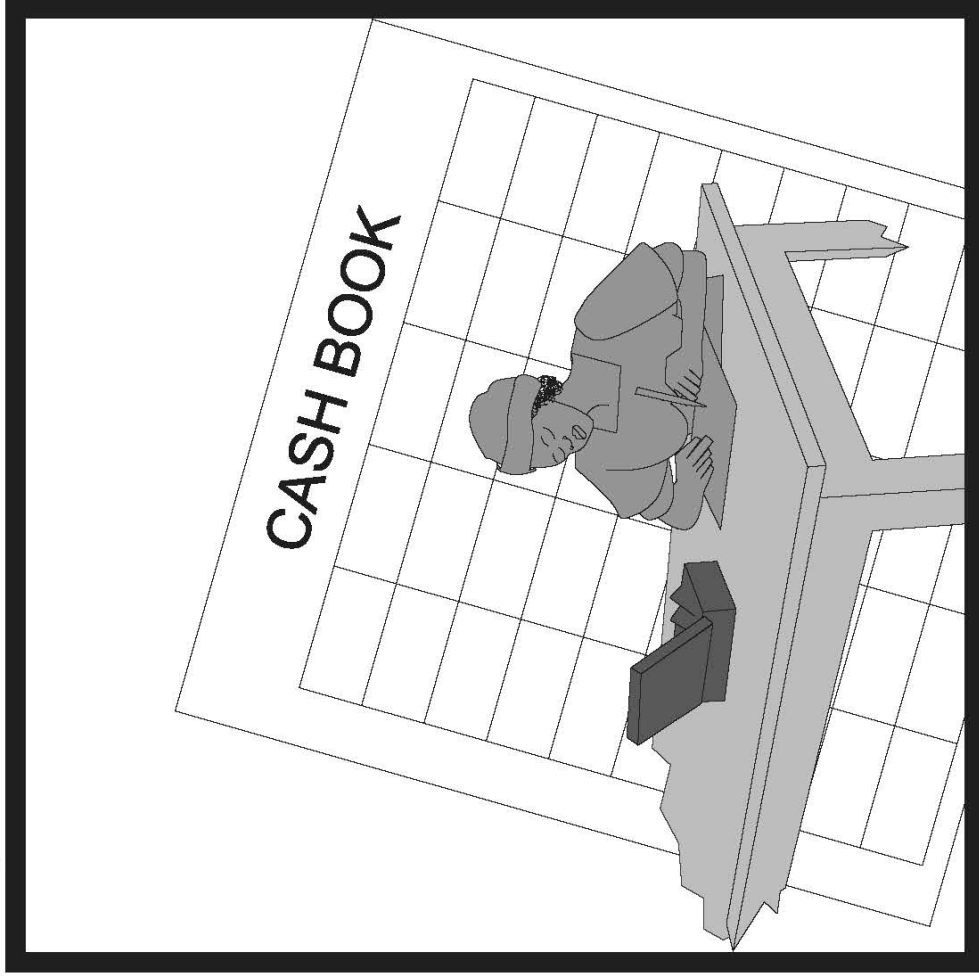

Salembere ndalama zolowa ndi zotuluka

Amalembere ndalama zolowa ndi zotuluka

X

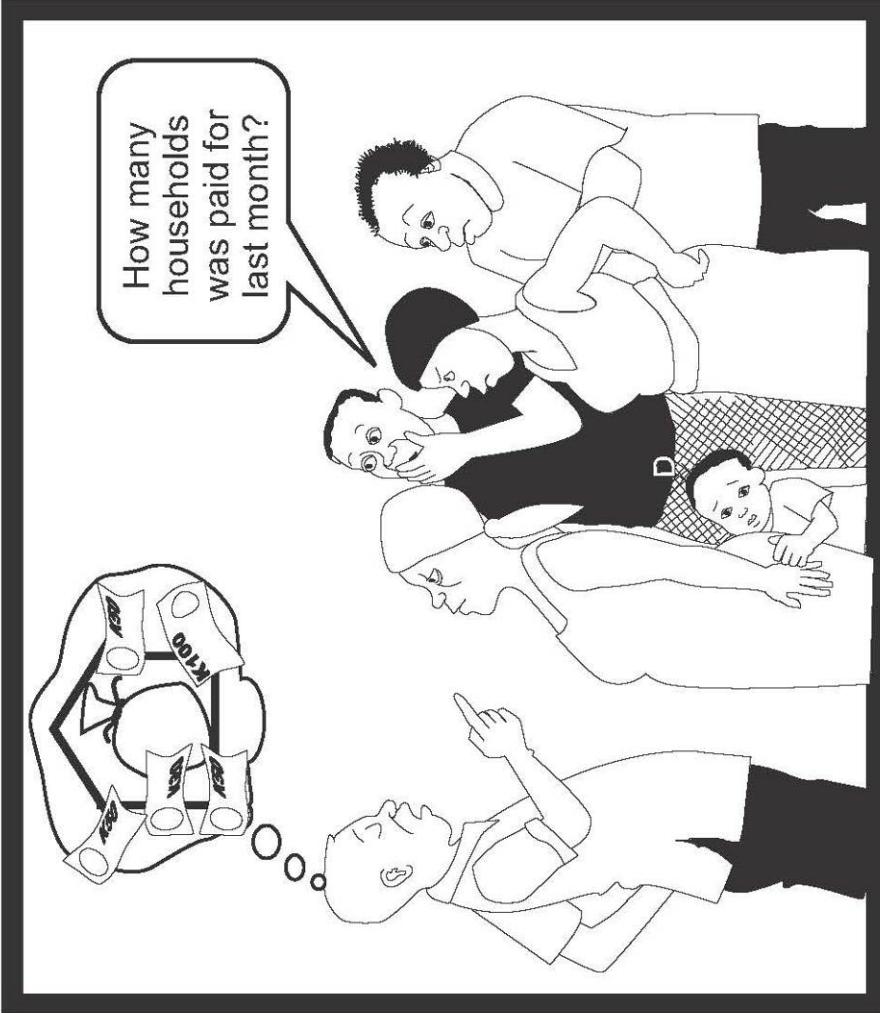

✓



Salembere kaundula wa anthu amene apereka ndalama za pa mjigo.

Amalembere kaundula wa anthu amene apereka ndalama za pa mjigo

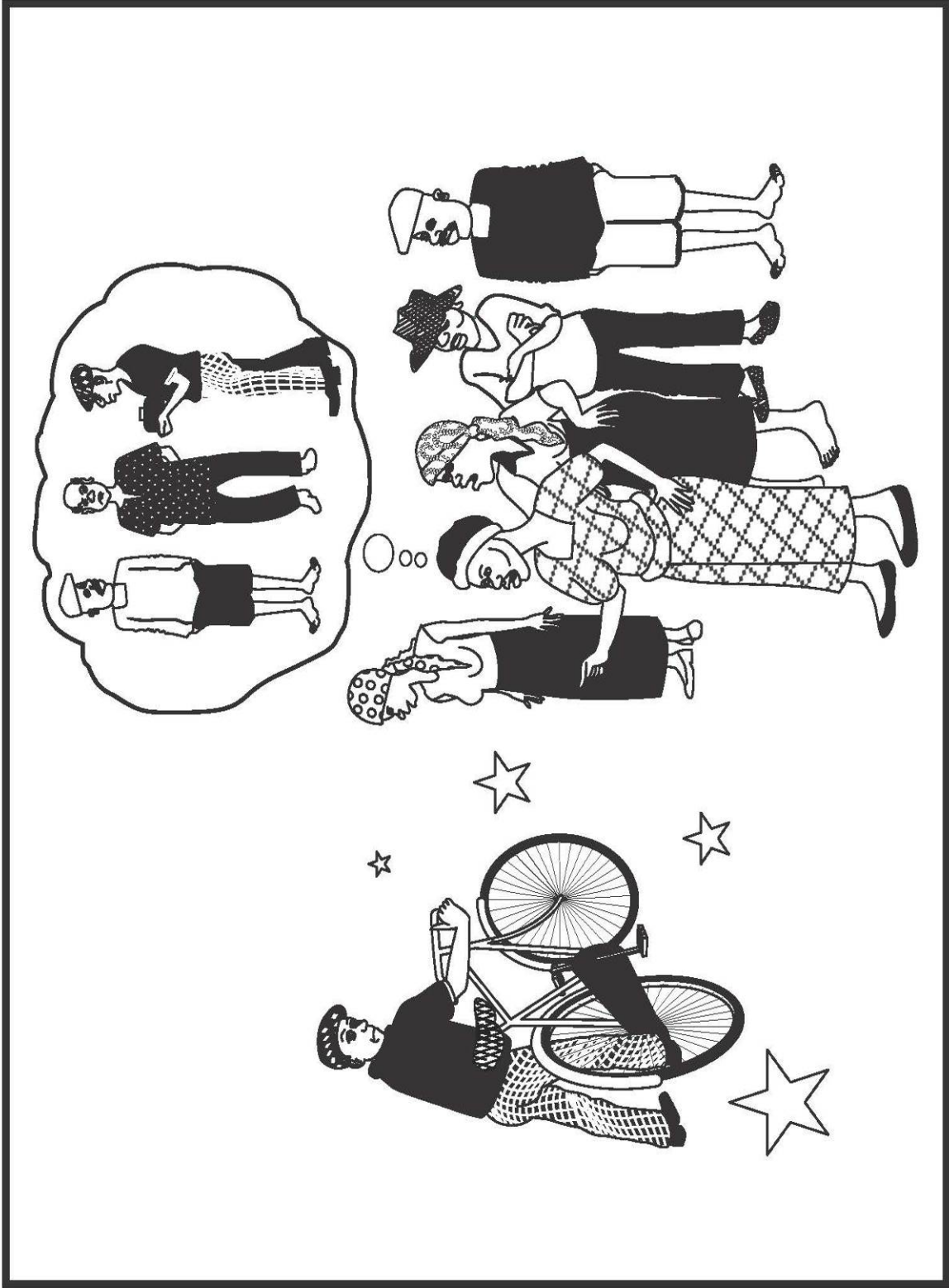

Msungi wagwiritsa ntchito ndalama za mjigo pa zinthu zina zolakwika.

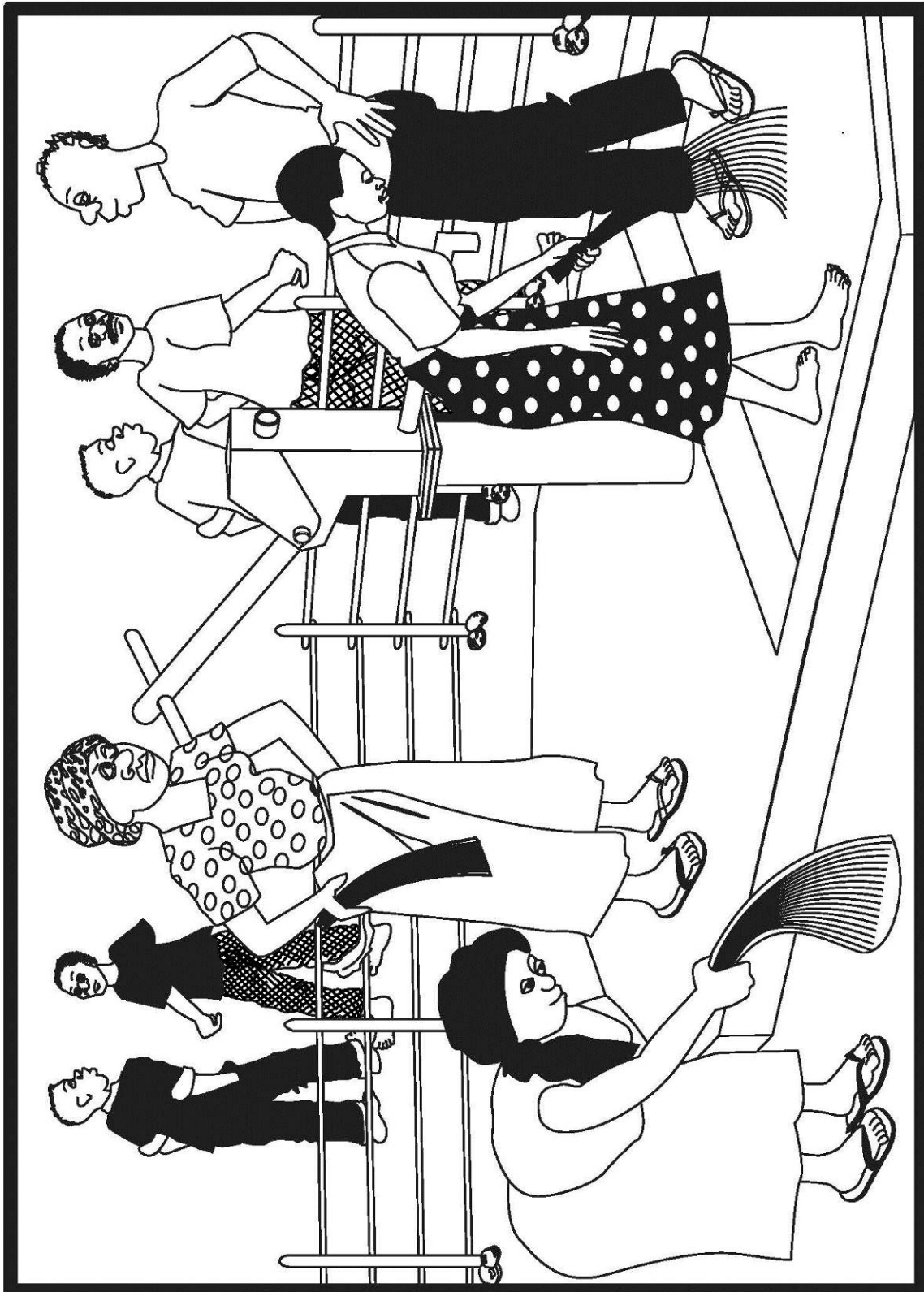

Abambo satenganawo mbali pa ntchito yosea pa mjigo.

X



✓



Akomiti sanakambirane ndi anthu pokhazikitsa mtengo wosonkha pa mjigo.

Akomiti anakambirana ndi anthu pokhazikitsa mtengo wosonkha pa mjigo.



Anthu akumwa madzi opanda ukhondo kuchokera ku zithaphwi, zitsime komanso madambo.

Tool 3

Sample Trainig Timetable for CBM O&M Refresger Course

Chitsanzo cha ndondomeko ya maphunziro achibwereza a komiti ya madzi

DONGOSOLO LA MAPHUNZIRO ACHIBWEREZA A KOMITI YA MADZI

Nthawi	Zochita	Njira Yo Phunzitsira	Wophunzitsa
TSIKU LOYAMBA			
8:30 - 8.45	<ul style="list-style-type: none"> • Kudziwana ndi mmene tikhalire • Kukambilana ndondomeko ya maphunziro athu • Chiyembekezo chathu ndi matha omwe tilinawo 	kukambilana	CDA/AM/HSA
8:45 - 8.50	<ul style="list-style-type: none"> ▪ Kutsegulira maphunziro 	Zoyankhula	DWDO/WMA
8.50 - 9.30	<ul style="list-style-type: none"> • Kumvetsa cholinga cha maphunziro • Kuzindikila mavuto okhuza kasamalidwe ndi kagwiritsidwe ntchito ka Mjigo wathu • Tingathetse bwanji mavuto amene tapeza 	Kuphunzitsa Kukambilana	CDA
9:30 - 10:30	<ul style="list-style-type: none"> • Kasamalidwe ka chuma cha pa Mjigo <ul style="list-style-type: none"> ❖ Msalamila za kasamalidwe ka chuma ❖ Kukhazikitsa mtengo ndalama zosonkha pa mjigo wathu ❖ Chitsanzo cha mmene tingakhazikitsile mtengo wa msonkho wa pa Mjigo ❖ Kusunga ndi kusamalira ndalama za pa mjigo ❖ Chitsanzo cha mmene tingalembere mu mbuku la Msonkhansonkha ndi Kashi Buku 	Kukambilana Kuphunzitsa Kuwonetsa chitsanzo cha kalembedwe ka buku la ndalama	CDA
10:30 - 10:45 KUPUMA			
10:45 - 11:45	<ul style="list-style-type: none"> ❖ Zida zothandiza kulimbikitsa anthu kusonkha ndalama ya pa mjigo(Nyimbo ndi Kusainila a mfumu zichitike) 	Kusaina fomu ndi kuyimba nyimbo yolimbikitsa anthu kusonkha ndalama za pa mjigo	CDA
11:45 - 12:15	<p>Ukhondo wa pa mjigo</p> <ul style="list-style-type: none"> ❖ Kuzindikila zinthu zomwe zinga pangitse kuti madzi a pa mjigo awonongeke ❖ Kukaona mavuto omwe ali pa Mjigo wathu pa nkhani za ukhondo. ❖ Kuchita chiganizo posankha kumanga zinthu zomwe zingathandize kusamala pa mjigo wathu 	Kuphunzitsa Kukambilana Kukambilana m' magulu	SHSA/ HSA
12:15 – 13:15 NKHOMALIRO			
13:15 - 14:15	<ul style="list-style-type: none"> ❖ Zida zolimbikitsa ukhondo wa pa mjigo 	Kuyimba nyimbo ndi kusaina fomu yolimbikitsa ukhondo pa mjigo	SHSA/ HSA

Nthawi	Zochita	Njira Yo Phunzitsira	Wophunzitsa
14:15 - 15:30	<ul style="list-style-type: none"> Kuona ndi kuzindikila zida za pa mjigo ❖ Mbali zomwe zimapanga mjigo ❖ Zipangizo za mjigo wa Afridev ❖ Kapopedwe ka madzi pa mjigo ❖ Ndondomeko ya kasamalidwe ndi kukonza mjigo wathu ❖ Kufufuza mavuto a pa mjigo wathu 	kuphunzitsa Kukambilana pa gulu Kuonetsa zithu zomwe tikukambilana	WMA/AM
15:30 - 15:45 KUPUMA			
15:45 – 16:15	<ul style="list-style-type: none"> Udindo wa athu osiyanasiyana pa mjigo Maudindo a anthu onse atchulidwe ndi kulembedwa bwino lomwe monga udindo wa mfumu, Akomiti, athu am'mudzi, alangizi onse. 	Kuphunzitsa Kukambilana	WMA/AM/CDA
16:15 – 16:30	<ul style="list-style-type: none"> Kuunikanso maphunziro atsiku limenero Kuunika mmene aphunzitsi athu agwirira ntchito 	Kukambilana Kulemba	HSA/CDA/WMA Ophunzira
TSIKU LA CHIWIRO			
8:30 – 9:00	<ul style="list-style-type: none"> Kuonanso zomwe tinaphunzira dzulo (Kuyesela kuyimba nyimbo zomwe taphunzira) 	Kukambilana Kuphunzitsa	SHSA/CDA/WMA
9:00 - 10:00	<ul style="list-style-type: none"> Amisili okonza Mjigo Chiyambi cha amisili okonza mjigo ndi Msika wa zipangizo za mjigo. Chiyambi cha msika wa zipangizo za mjigo 	Kukambilana Kuphunzitsa	WMA/AM
10:00 - 10:15 KUPUMA			
10:15 - 12:15	<ul style="list-style-type: none"> Kukhazikitsa ndondomeko(Pulani) ya mmene tiwusamalire mjigo wathu ❖ Pulani ya kasamalidwe ka mjigo wathu ❖ Chitsanzo cha mmene tingalembere (Pulani) zomwe tichite kuyambila panopa Kumemeza mudzi wonse pa nkhani za pa mjigo Njira zolimbikitsila kuti mudzi wonse uzitengapo mbali pa za mjigo wathu Kalondolondo wa pa mjigo wathu ❖ Kulondola zomwe tina gwirizana pa Msonkhano woyamba. 	Kuphunzitsa Kukambilana Ntchito yokonza pulani	CDA/HSA
12:15 – 13:15 NKHOMALIRO			
13:15 - 15:15	<ul style="list-style-type: none"> Ntchito yokonza ndondomeko (Pulani) ya mmene tiyendere kuyambila lero Chitsanzo cha mmene tingalembere Pulani (yeserani kulemba Pulani) 	Keyeselera kuchita	CDA/HSA, WMA/AM
15:15 - 15:30 KUPUMA			
15:30 - 16:00	<ul style="list-style-type: none"> Kutsendera zomwe taphunzira Kuunika aphunzitsi m'mene aphunzitsira 	Kukambilana	CDA/HSA, WMA/AM
16:00 – 16:15	<ul style="list-style-type: none"> Kutsekera maphunziro 	Zoyankhula	DWDO/ WMA/CDA/HSA,

Tool 4

Tariff Setting Booklet (Afridev Handpump Version)

Buku la m'mene tingakhazikitsire mtengo wosonkha pa mjigo.

Kukhazikitsa msonkho wa madzi



Komiti yowona za mjigo



Mlangizi



Zoti tiphunzire



Alangizi mutiphunzitsa chiyani lero?



Lero tikuphunzitsani za ubwino wopereka ndalama ndi kukhazikitisa msonkho woyendetsera ndi kukonzera mijigo. setting of O&M cost.

- **Mutu wa Phunziro: Ubwino wosonkha ndalama zoyendetsera ndi kukonzera mijigo**
- **Mitu Yotsatira:**
- 1. Kusamalira ndi kukonza mijigo nkofunikira bwanji?
- 2. Pamafunika ndalama zingati zoyendetsera, kusamalira ndi kukonzera mijigo panthawi ya umoyo wake.
- 3. Kodi ndalama zoyendetsera ndi kukonzera mijigo imeneyi amasonkha ndi ndani?
- 4. Kodi msonkho wa madziwu tingakhazikitse bwanji?

Phunziro Loyamba :

**Ndi chifukwa chiyani kukonza ndi kusamalira
mijigo kuli kofunika?**

Phunziro Loyamba : Ndi chifukwa chani kukonza ndi kusamalira mijigo kuli kofunika?



Kodi Alangizi,
zotsatira za
kusamala ndi
kusakonza mijigo
zimakhazotani?



Mijigo
imaonongeka
pafupipafupi,
komanso umoyo
wake umakhala
ukuhepera
chepera.



Phunziro Loyamba : Ndi chifukwa chani kukonza ndi kusamalira mijigo kuli kofunika?



Eya



Ndifotokoza zambiri zomwe zimachitika ngati mijigo sikusamalidwa komanso kukonzedwa nthawi

Kagwiridwe kake ka ntchito kamachepa mphamvu nthawi ikamapita. Ndipo izi zikapitilira, mijigo imatha kuferatu.



Pamapeto pake kukhazikitisa mijigo watsopano kuti ubwenzeretse wakalewo kumakhala kokwera mtengo komanso panthawi yoyembekezera kusinthaku anthu ogwiritsa ntchito mijigoyi amakhala opanda njira zokwanira zopezera madzi.

Phunziro loyamba: Ndi chifukwa chani kukonza ndi kusamalira mijigo kuli kofunika?



Kutsendela phunziro loyamba
Kusamalira ndi kukonza mijigo mkofunikira kwambiri kuti umoyo wa mjigo ukhale wautali ndi okhazikika.



Ndamvetsetsa
alangizi

Phunziro lachiwiri :

Kodi pamafunika ndalama zingati zokonzetsera ndi kuyendetsera mijigo panthawi ya umoyo wake?..

Phunziro lachiwiri : Kodi pamafunika ndalama zingati zokonzetsera ndi kuyendetsera mijigo panthawi ya umoyo wake? .



Aphunzitsi kodi ndi mbali ziti zachuma choyendetsera ndi kusamalira mijigo zomwe tikuyenera kulingalira?



Tikuyenera kulingalira za umoyo wake wa mijigowo.



Kodi tikati umoyo wa mijigo ndiye kuti chiyani?

Phunziro lachiwiri: Kodi pamafunika ndalama zingati zokonzetsera ndi kuyendetsera mijigo panthawi ya umoyo wake?.



Khanda

Jakisoni woteteza kumatenda



ubwana

Opaleshoni wamkulu

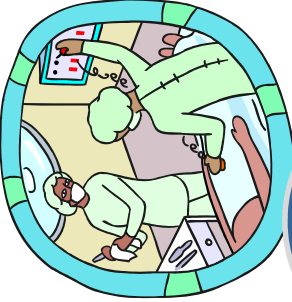

ukalamba



Umoyo wa mijigo umakhala ngati umoyo wa munthu.

Mpamba



Kuyendetsa ndi kukonza



Kukonzanso, Kubwezeretsa ndi kukhazikizanso.

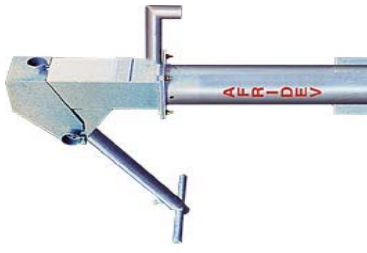

Phunziro lachiwiri: Kodi pamafunika ndalama zingati zokonzetsera ndi kuyendetsera mijigo panthawi ya umoyo wake.



Kodi umoyo wa zipangizo za mijigo umakhala wautali bwanji?



Tangowonani mu tebulo liri m'musimu kuti mijigo umakhala pafupifupi za makumi awiri.

Mphambu/ Katundu	Zaka za umoyo wake	ECONOMIC (DESIGN) LIFE IN YEARS
Mijigo	Makumi awiri (20)	20
Chigwiriro cha pampu	Zaka zisanu ndi ziwiri mpaka khumi(7-10)	7-10
Injini ya Dizilo / tizida tina ndi tina	Zaka khumi (10)	10
Injini ya magetsi / tizida tina ndi tina	Zaka khumi mpaka khumi ndi zisanu (10-15)	10-15
Thanki yosungiramo madzi yokhala pa miyala kapena pa konkiliti	Zaka makumi atatu mpaka anayi (30-40)	30-40
Thanki yokhala pamwamba pa zitsulo	Zaka khumi ndi zisanu mpaka makumi awiri (15-20)	15-20
Manyumba, Miyala	Zaka makumi atatu (30)	30
Madzi apa khomo	Zaka khumi ndi zisanu (15)	15
Sistine zosadzama zokhala ndi pampu ya m'manja	Zaka khumi (10)	10
Ma gantala, ntchito zina za zitsuro etc.	Makumi awiri (20)	20

Phunziro lachiwiri: Kodi pamafunika ndalama zingati zokonzetsera ndi kuyendetsera mijigo panthawi ya umoyo wake.

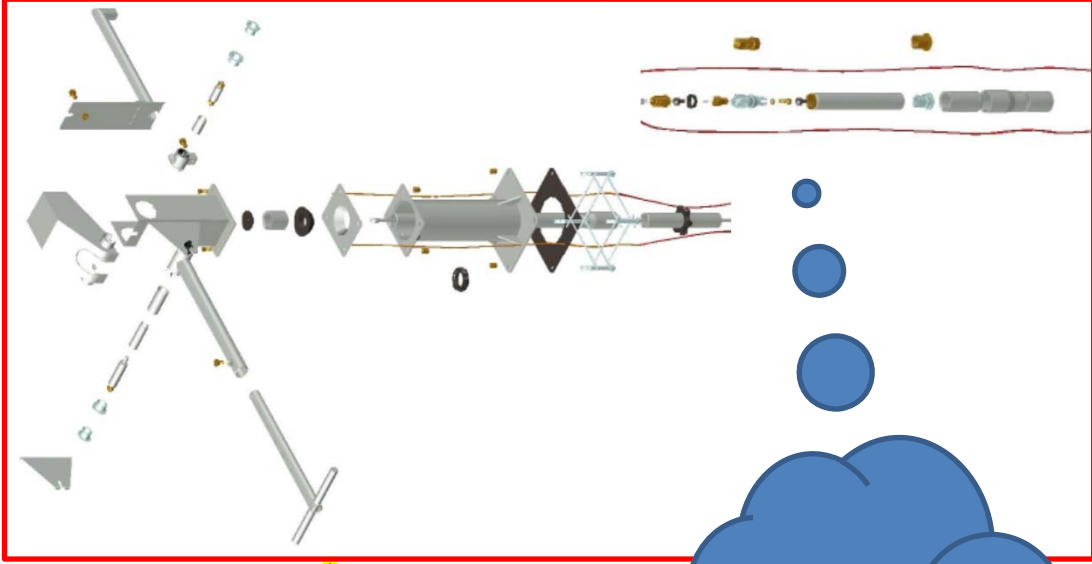

Pampuyi ili ndi zipangizo zambiri ndipo chipangizo chilichonse chili ndi umoyo wake.



Pano, tiyeni tiphunzire za ndalama mokhudzan a ndi umoyo wa pampu yotchewa Afridev.



Eya

Phunziro lachiwiri: Kodi pamafunika ndalama zingati zokonzetsera ndi kuyendetsera mijigo panthawi ya umoyo wake.



M'munsimu muli tebulo losonyeza umoyo ndi kasinthidwe ka zipangizo za pampu ya Afridevu.

Dzin La Chipangizo	Chithunzi	Nthawi yowwerezesa zipangizo		Dzin La Chipangizo		Chithunzi	Nthawi yomve chipangizo chingafunike kusinthira	
		Zaka zoyembekera kuti chipangizo chigwira nthito hawino	Nthawi yoyenera kusitha chipangizo	Rayizing'i paipi	Rayizing'i paipi		Zaka zitatatu kapena Zisanu	Nthawi yoyenera kusitha chipangizo
Mitu wa Pampu ndi Handulo	Fakalamu pini		Zaka zisanu mpaka zisanu ndi zitatu	sinthani ngati nkofunikira	Rayizing'i paipi		Zaka zitatatu kapena Zisanu	sinthani ngati nkofunikira
	Hang'ala pini		Zaka zisanu mpaka zisanu ndi zitatu	sinthani ngati nkofunikira	Topu Silivi		Zaka zitatatu kapena Zisanu	sinthani ngati nkofunikira
	Rodi hang'ala		Zaka zisanu mpaka zisanu ndi zitatu	sinthani ngati nkofunikira	Fulapa		Zaka zitatatu kapena Zisanu	sinthani ngati nkofunikira
	Bering'i bushi ya kunjia		Chaka chimodzi kapena Ziwiriri	Chaka chili chonse	Sentilaiza wa ma ichi anayi		Zaka zitatatu kapena Zisanu	sinthani ngati nkofunikira
Pampu rodi	Pampu rodi		Zaka zitatatu kapena Zisanu	sinthani ngati nkofunikira	Pampu silinda		Zaka zisanu mpaka zisanu ndi zitatu	sinthani ngati nkofunikira
	Sentilaiza		Zaka ziwiriri mpaka Zitatu	Zaka ziwiriri zili zonse	Valavu		Zaka zitatatu kapena Zisanu	sinthani ngati nkofunikira
Pulanja ndi fitu Valavu	O-ring'i		Zaka ziwiriri mpaka Zitatu	Zaka ziwiriri zili zonse	O-ring'i		Zaka ziwiriri mpaka Zitatu	Zaka ziwiriri zili zonse
	Bobini		Zaka ziwiriri mpaka Zitatu	Zaka ziwiriri zili zonse	U-Siko		Chaka chimodzi kapena Ziwiriri	Chaka chili chonse

Phunziro lachiwiri: Kodi pamafunika ndalama zingati zokonzetsera ndi kuyendetsera mijigo panthawi ya umoyo wake.



Eya



Malingana ndi mfundo zomwe zaperekedwe mmunsimu, tiyeni tiwerengere ndalama zimene zingafunike pa umoyo wa pampu ya Afridevu.

Zimene zingafunike kuti tiwerengere ndalama zoyendetsera ndi kukonza mijigo wa Afridevu.

1. Zoyenera Kugula:

Ndalama zimene zingafunike pakubwezeretsa zipangizo za pampuyi molingalira za umoyo wake.

- a. Ndalama zoyendera pokagula zipangizo
- b. Ndalama zolipira m'misili wokonza mijigo kuti utetezeke.
- c. Ndalama zofunika pobwezeretsa pampu yonse ya afridevu.

2. Mtengo woyambira wa zipangizo:

- a. Okotobala 2012
- b. Kakweredwe ka zinthu: ma peresenti asanu (5%)

3. Nthawi yoyenera kubwezeretsa pampu ya mmanja ya mtundu wa Afridev: Zaka khumi ndi zisanu (15 zaka)

Phunziro lachiwiri: Kodi pamafunika ndalama zingati zokonzetsera ndi kuyendetsera mijigo panthawi ya umoyo wake.

Mzele wa mtambo ukusonyeza chumachonse chokundika choyendetsera ndi kukonzera pampu chomwe ndichokwanira pafupifupi zikwizikwi ndi zikwi mazana anayi (1,400,000)

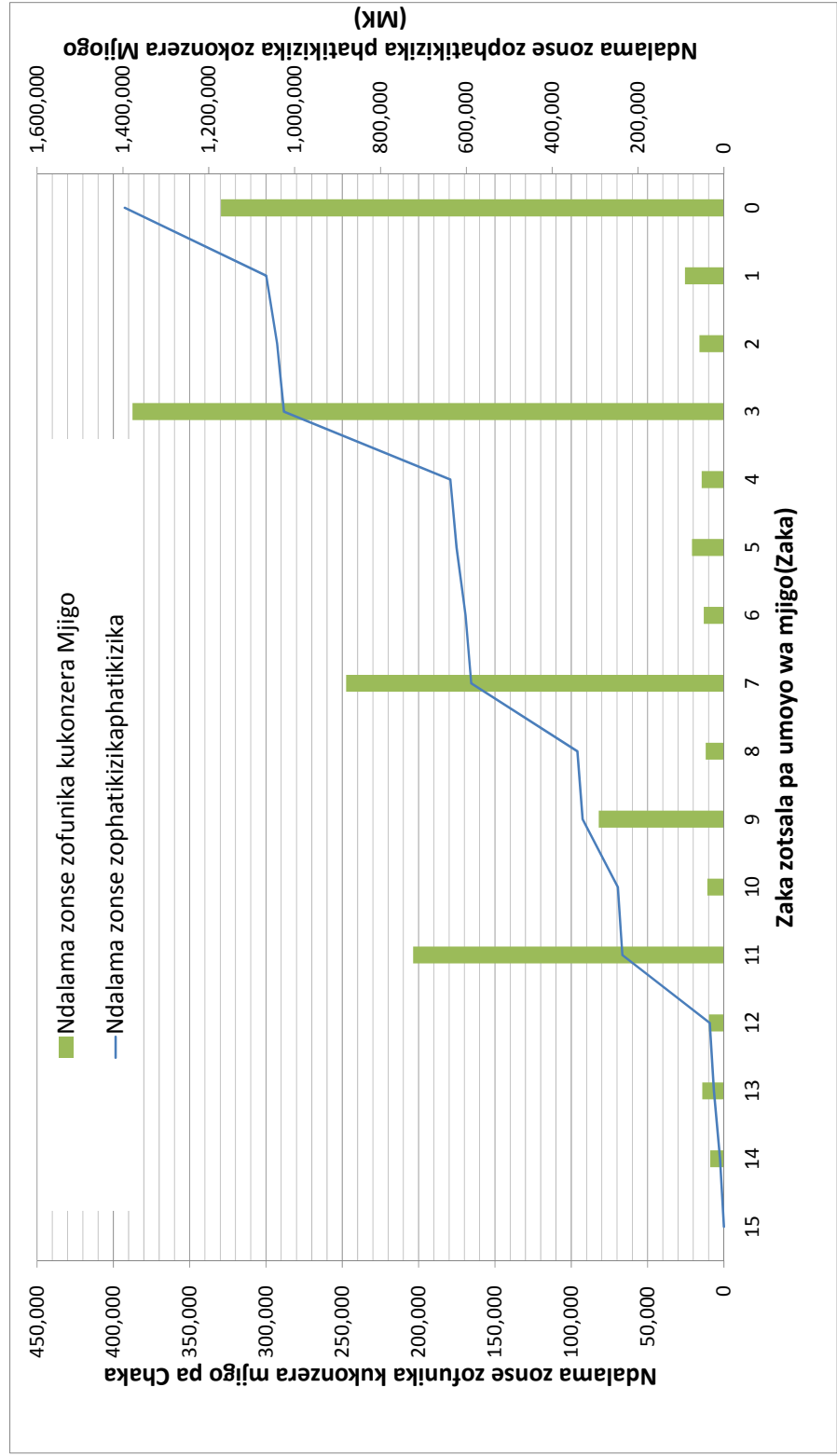

Phunziro lachiwiri: Kodi pamafunika ndalama zingati zokonzetsera ndi kuyendetsera mijigo panthawi ya umoyo wake.



Kutsendera phunziro la chiwiri

- Ndalama zonse zoyendetsera ndi kukonza kuphatikizapo ndalama zobwezeretsera pampu yatsopano ndi: 1,395,751 MK
- Mlingo wa ndalama zoyendetsera ndi kukonza pa chaka :
= (Zonse pamodzi) kugawitsa ndi (zaka khumi ndi zisanu kuphatikizapo chaka chimodzi)
= $1,395,751 \div 15$ 93,050 MK



Ndamvetsetsa
Alangizi

Phunziro lachiwiri: Kodi pamafunika ndalama zingati zokonzetsera ndi kuyendetsera mijigo panthawi ya umoyo wake.

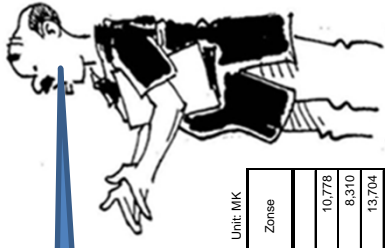

Mmusimu muli chitsanzo cha m'mene tingawerengere

No.	Zipangizo za mijigo	Zaka zotsala pa umoyo wa mijigo (Zaka)													Unit: MK						
		2013	2014	2015	2016	2017	2018	2019	2020	2021	2022	2023	2024	2025	2026	2027	2028	Zonse			
A-1	Fakalamu pini Asemble	0	0	0	0	0	0	4,606	0	0	0	0	0	0	0	0	6,172	0	0	10,778	
A-2	Hangi pini Asemble	0	0	0	0	0	0	3,951	0	0	0	0	0	0	0	0	4,759	0	0	8,310	
A-3	Rodi Hanga Asemble	0	0	0	0	0	0	5,886	0	0	0	0	0	0	0	0	7,848	0	0	13,704	
A-4	Bushi beiringi wa kunjia	0	2,205	2,315	2,431	2,553	2,680	2,814	2,955	3,103	3,258	3,421	3,582	3,771	3,960	4,158	4,366	4,581	4,806	47,581	
A-5	Bushi beiringi wa mikali	0	2,205	2,315	2,431	2,553	2,680	2,814	2,955	3,103	3,258	3,421	3,582	3,771	3,960	4,158	4,366	4,581	4,806	47,581	
A-6	Topu Rodi Asemble	0	0	0	0	0	0	6,088	0	0	0	0	7,401	0	0	0	8,995	0	0	22,484	
A-7	Pampu Rodi Asemble	0	0	0	0	0	72,930	0	0	86,647	0	0	107,751	0	0	0	134,665	0	0	269,329	
A-8	Senteleza	0	0	3,599	0	3,967	0	4,374	0	4,822	0	5,317	0	5,862	0	6,462	0	7,119	0	34,403	
A-9	Reza paipi asemble	0	0	0	0	51,207	0	0	62,242	0	0	0	75,656	0	0	0	90,000	0	0	189,105	
A-10	Reza paipi	0	0	0	0	36,465	0	0	44,324	0	0	0	53,876	0	0	0	64,388	0	0	134,665	
A-11	Razngi meni	0	0	0	0	669	0	0	813	0	0	0	988	0	0	0	1,191	0	0	2,469	
A-12	Julapa	0	0	0	0	462	0	0	561	0	0	0	682	0	0	0	823	0	0	1,706	
A-13	Senteleza 4"	0	0	0	0	5,105	0	0	6,205	0	0	0	7,543	0	0	0	9,086	0	0	18,853	
A-14	Sinde Asemble	0	0	0	0	0	0	47,840	0	0	0	0	63,843	0	0	0	83,846	0	0	111,483	
A-15	Vavu body Asemble	0	0	0	0	15,012	0	0	18,247	0	0	0	22,179	0	0	0	26,314	0	0	55,437	
A-16	Kukonza koteza ndi Amakani	0	0	181	0	199	0	220	242	0	267	0	295	0	325	0	358	0	392	1,729	
A-17	Bobni	0	0	551	0	608	0	670	739	0	814	0	898	0	990	0	1,088	0	1,191	5,270	
A-18	Pulanja ndi Futuvavu	0	0	286	0	315	0	347	383	0	422	0	465	0	513	0	562	0	611	2,730	
A-19	Kapu silo ya pulanja wa chisulo	0	0	181	0	199	0	220	242	0	267	0	295	0	325	0	358	0	392	1,729	
A-20	Naitiraelo labala wa mifundo yonse ya pulanja ndi Usilo	0	309	324	340	357	375	394	414	434	456	479	503	528	554	582	611	641	671	6,661	
A-21	Gasketi	0	0	0	0	0	0	1,861	0	0	0	0	2,082	0	0	0	2,363	0	0	3,653	
A-22	Komprehoni koni	0	0	0	0	0	0	1,548	0	0	0	0	1,774	0	0	0	2,074	0	0	3,622	
A-23	Pampu yonse ya Aifirevu	0	0	0	0	0	0	0	0	0	0	0	0	0	0	0	0	0	0	311,839	
B	Kulipira wokonza																				
B-1	Kukonza koteza ndi Amakani	0	3,150	3,308	3,473	3,647	3,829	4,020	4,221	4,432	4,654	4,887	5,131	5,388	5,657	5,940	6,237	6,540	6,851	67,972	
B-2	Kukonza chitawonongeka	0	0	0	0	0	0	0	0	0	0	0	0	0	0	0	0	0	0	0	
B-3	Kukonza kukwonongeka kwa dzidzi	0	0	0	0	0	0	0	0	0	0	0	0	0	0	0	0	0	0	0	
B-4	Kukonza Chitsime chonse poyikizila zina zaisopano	0	0	0	0	0	0	0	0	0	0	0	0	0	0	0	0	0	0	0	
B-5		0	0	0	0	0	0	0	0	0	0	0	0	0	0	0	0	0	0	0	
B-6		0	0	0	0	0	0	0	0	0	0	0	0	0	0	0	0	0	0	0	
C	Zina																				
C-1	Mayendelwe	0	1,050	1,103	1,158	1,216	1,276	1,340	1,407	1,477	1,551	1,629	1,710	1,796	1,886	1,980	2,079	2,182	2,287	22,657	
C-2	Chiteetezo cha pa mijigo (Kulipira mionda wa pa mijigo)	0	0	0	0	0	0	0	0	0	0	0	0	0	0	0	0	0	0	0	
C-3		0	0	0	0	0	0	0	0	0	0	0	0	0	0	0	0	0	0	0	
C-4		0	0	0	0	0	0	0	0	0	0	0	0	0	0	0	0	0	0	0	
C-5		0	0	0	0	0	0	0	0	0	0	0	0	0	0	0	0	0	0	0	
	Ndalama zonse zofunika kukonzera Mjigo	0	8,919	14,162	9,833	203,551	10,841	81,976	11,952	247,418	13,177	20,923	14,528	387,526	16,017	25,432	329,498	1,395,751			
	Ndalama zonse zophatikiziphatikizika	0	8,919	23,980	32,913	236,464	247,305	329,281	341,233	368,651	401,528	432,751	462,279	490,805	518,821	547,451	576,674	606,501	636,926	667,951	6,661

Phunziro lachitatu :

Kodi woyenera kupereka ndalama zoyendetsera ndi kukonza mijigo ndi ndani?

Phunziro Lachitatu: Kodi woyenera kupereka ndalama zoyendetsera ndi kukonzetsera mijigo ndi ndani?



Kodi mitengo ya zipangizo zoperekera madzi imagawidwa bwanji kuno ku Malawi?



Malingana ndi a unduna owona za chitukuko cha madzi kuno ku Malawi, mitengoyi imapangidwa motere:

Zofunika ndalama	Zingati	Bungwe loyenera kuchita	Kochokera umboni
Mpamba	Mudzi upereke ndalama yoyambira (ma peresenti asanu ampamba wa ndondomeko yogawira madzi pamudzi). Ndalama zonse za mpamba (pamayambiro penipeni)	Midzi Boma kapena mabugwe ena othandiza	a. Key strategies (page 2), District Operation Manual, Water Supply and Sanitation, July 2010
Ndalama zoyendetsera ndi kukonza kuphatikizapo ndalama zosungana zobwezeretsera ndi kuchulutsa mijigo.	Maperesenti zana a ndalama zoyendetsera ndi kukonza	Midzi	Key strategies (page 2 and 10), District Operation Manual, Water Supply and Sanitation, July 2010

Phunziro Lachitatu: Kodi woyenera kupereka ndalama zoyendetsera ndi kukonzetsera mijigo ndi ndani?



Kutsendera phunziro lachitatu

Mudzi uyenera kutengapo mbali pa chuma chonse choyendetsera ndi kukonzetsera komanso kukhala ndi thumba lapadera lothandizira kubwezeretsa ndi kuwonjezera mijigo.



Ndamvetsetsa alangizil

Phunziro Lachinayi:

Kodi tingakhazikitse bwanji msonkho wa madzi?

Phunziro la chinayi: Kodi tingakhazitse bwanji msonkho wa madzi?



Eya

Pano, tiyeni tiphunzire za msokho wa madzi omwe khomo lililonse lingasonkhe pa chaka.



Kuti tipeze nsonkho umenewu pafunika kudziwa zotsatirazi.



■ Zofunika kudziwa

Chiwerengero cha mabanja omwe amagwiritsa ntchito mjigowu pamudzi.

Phunziro Lachinayi : Kodi tingakhazikitse bwanji msonkho wa madzi?



Ndifotokozza za chitsanzo cha mmene tingakhazikitsire misonkho ya pampu ya Afridevu pa khomo lirilonse.

Bokosi Ioyamba: Kukhazikitsa msonkho wa madzi pa banja lilironse

Tigwiritsa ntchito chitsanzo cha kayendetsedwe ndi kakonedwe ka pampu ya Afridevu :

1. Zofunika:

Ndalama zonse zosonkhedwa pa chaka zoyendetsera ndi kukonzera:

M= 93,050 MK (onani pa phunziro lachiwiri)

Chiwerengero cha mabanja

N= Mabanja makumi asanu (50)

2. Njira Zowerengera:

Njira Yoyamba: Msonkho wa pa chaka pa banja lilonse :

$$\begin{aligned} &= \text{Msonkho wa mudzi wonse wa pa chaka} \div \text{Mabanja onse pa mudzi} \\ &= 93,050 \div 50 = \mathbf{1,870 \text{ MK/chaka/Banja}} \end{aligned}$$

Njira ya chiwiri: Msonkho wa banja lililonse pa mwezi:

$$\begin{aligned} &= \text{Msonkho wa pachaka} \div 12 \text{ miyezi} \\ &= 1,870 \div 12 = \mathbf{160 \text{ MK/mwezi/ Banja}} \end{aligned}$$

Phunziro Lachinayi : Kodi tingakhazikitse bwanjji msonkho wa madzi?

Pulani ya ndalama ili mmusi mu tebulomu



Chaka choyambira	Chaka	Zolowa	Zotuluka	Zotsala
15	2013	93,050	0	93,050
14	2014	93,050	8,919	177,181
13	2015	93,050	14,162	256,069
12	2016	93,050	9,833	339,286
11	2017	93,050	203,551	228,785
10	2018	93,050	10,841	310,995
9	2019	93,050	81,976	322,069
8	2020	93,050	11,952	403,167
7	2021	93,050	247,418	248,799
6	2022	93,050	13,177	328,672
5	2023	93,050	20,923	400,799
4	2024	93,050	14,528	479,321
3	2025	93,050	387,527	184,844
2	2026	93,050	16,017	261,877
1	2027	93,050	25,433	329,494
0	2028		329,498	

Phunziro Lachinayi: Kodi tingakhazikitse bwanji msonkho wa madzi?



Kutsendera phunziro lachinayi

- Msonkho wa pa chaka :
1,870 MK/Pachaka/Banja lililonse
- Msonkho wa pa mwezi :
160 MK/Pamwezi/Banja lililonse



Ndamvetsetsa
alangizi

Kodi mwamvetsetsa pa mitu
yomwe taphunzirayi?. Panopa
tiyeni tiwone kukhazikitsa
msokho wa pa khomo ndi
kayendetsedwe ka chuma?



Eya Alangizi



Tool 5

Form of User Contribution Book

Buku la kaundula wa msonkhansonkha

Buku la Kaundula wa msonkhasonkha

TA: Zulu	Mudzi: Mtanga
Nambala ya Mjigo.: Mtanga 1	Tsiku: 1/1/2016

e. Ndalama zomwe banja lililonse lisonkhe pa chaka ndi: 1,200 MK

NO	Dzina	a. Ngongole ya chaka chatha (2014)	Ndalama za Mchakachino												c. Ngongole ya chaka Chino (=Zomwe banja lasonkha kuchotsa zomwe banja lililonse lisonkhe pa chaka) c = b- e	d. Ngongole ya chaka chino ndi chatha d = a+c		
			2015															
			JANUWALE	FEBULUWALE	MARICHI	EPULO	MEYI	JUNI	JULAYI	OGASITI	OKTOBALA	SEPTEMBALA	NOVEMBA	DISEMBA				
1	Ms. Phiri	0	100	100	100	100	100	100	100	100	100	100	100	100	100	1,200	0	0
2	Mr. Mphonda	-200	0	0	0	0	0	300	400	100	100	100	50	200	0	1,000	-200	-400
3	Mr. Mlangiza	-500	0	0	0	0	0	0	200	200	100	100	200	200	200	1,200	0	-500
4	Ms. Tembo	0	0	100	100	100	100	100	200	200	100	100	100	100	100	1,200	0	0
5	Ms. Mbewe	0	100	100	100	100	100	100	100	100	100	100	100	100	100	1,200	0	0
6	Mr. Zulu	-100	100	100	100	100	100	100	100	100	100	100	100	100	100	1,200	0	-100
7	Mr. Richard	-100	50	50	50	50	50	300	200	200	100	100	50	0	1,300	+100	0	

Tool 6

Form of Cash Book

Buku la ndalama zonse(Kashi Buku)

Tool 7

Promotion Song for Payment of Water (Water is Life)

Nyimbo yolimbikitsa kusonkha ndalama za pa mjigo.

SONG 1: MADZI NDI MOYO

VERSE 1

Ayoyoyooo ku mudziko yoyoyooo
Ukhondo wabwino umayamba ndi madzi
Tiyenera kumwa madzi olongosoka
Ichi ndi chifukwa chake Boma la Malawi
Likulimbikitsa kusamala mjigo
Koma izi kuti zitheke komanso zipitirire
Ndi udindo wa tonse kutenga mbali
Inu mafumu, village band, ma volontiya
Mukhale maso. Onetsetsani kuti aliyense
Akusonkha kangachepe nthawi zonse
Ndalama imeneyi ndiyothandiza kuti
Mjigo ukaonongeka tizitha kukonzaso

CHORUS

Lead: Madzi ndi moyo
All : Tiwasamale
Lead: Tilimbikitsane
All : kumwa madzi aukhondo
Lead: Ndalama zokonzera
All : Tizipereka
Lead: Kuti mjigo ukawongeka
All : Tizitha kukonzanso.

VERSE 2

Anthuni kupewa kumaposa kuchiza
Nkhanga zinapangana kusanapse
Khalani athanzi pomwa madzi a bwino a pa mjigo
Lipilani ndalama zokonzera mjigo
Ubwino wina wa madzi a pa mjigo
Kuphikira ndiwo sizichedwa kupsa

Awuzeni awo awuzenso ena
Tisathawe udindo popereka ndalama
Poti tikadwala tidzaononga
Ndalama zambiri komanso nthawi
Lipilani inu ndalama Kuti muzimwa madzi a bwino
BACK TO CHORUS

SOME TRADITIONAL TUNE

Lead Imwani madzi abwino
Back Tizimwa madzi abwino
Lead Madzi apa mjigo abwino
Back Madzi a pamjigo abwino
Lead Imwani madzi
Back Abwino, abwino aa
Lead Madzi a pamjigo
Back Abwino, abwino aa
Lead Kuti mukhale athanzi
Back Kuti mukhale athanzi
Lead Kuti mukhale
Back Athanzi, athanzi aa

CHORUS

Lead: Madzi ndi moyo
All : Tiwasamale
Lead: Tilimbikitsane
All : kumwa madzi aukhondo
Lead: Ndalama zokonzera
All : Tizipereka
Lead: Kuti mjigo ikawongeka
All : Tizitha kukonzanso

Tool 8

Village Head's Consensus Form for Promotion of Regular Payment of Water Fee

Fomu ya Chitsimikizo cha mfumu cholimbikitsa kupeleka ndalama za pa mjigo

Khalani a moyo wathanzi pakumwa madzi abwino a pamjigo

Lipilani ndalama zokonzera mjigo



Government of Malawi

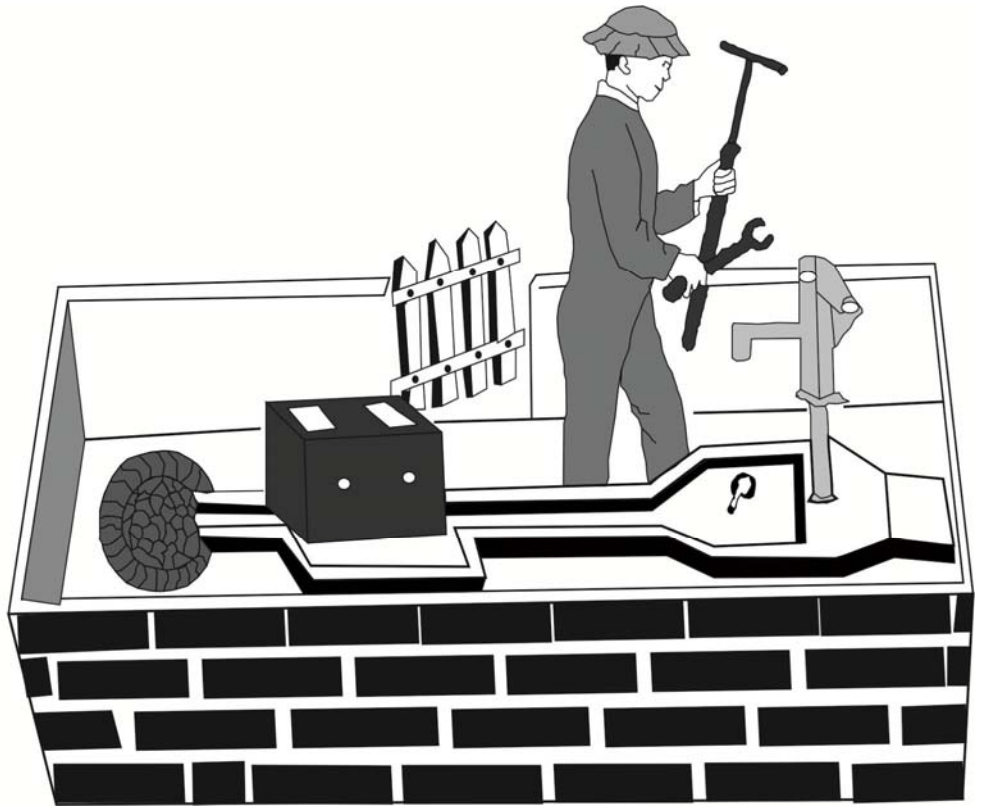

Ine, _____ wa m'mudzi
wa _____, ndikulonjeza kuti mudzi wathu
udzakhala wathanzi pakumwa madzi abwino nthawi zonse polipira ndalama
zokonzera mjigo nthawi ndi nthawi.

_____ (Dzina la Mfumu)

_____ (Saini)

_____ (Tsiku)

Pa maso pa:

_____ (Dzina la wapampando wa WPC)

_____ (Saini)

_____ (Tsiku)

ndi

_____ (Dzina la mboni)

_____ (Saini)

_____ (Tsiku)

MJIGO:

MUDZI:

Tool 9

Sanitary Inspection Survey Form

Fomu ya kauniuni wa ukhondo wa pa mjigo

Kauniuni wa ukhondo wa pamjigo

Tsiku:

Nyengo:

Dzina la ofunsa mafunso:

Site No.:

Mudzi:	TA:	H/C:
Agulupu:	Dzina la Malo:	
Jogalafe ya malo	Kum'mwera:	Kummawa:

Mlangizi wa zaumoyo wa dela	Dzina:	Nambala ya foni:
Amfumu	Dzina:	Nambala ya foni:
Wapampando wa Komiti ya Madzi	Dzina:	Nambala ya foni:
Wolemekezeka	Dzina:	Nambala ya foni:

No	Zomwe zikufunika	Pali chiopsezo		Ndemanga
		Eya	Ayi	
1	Kodi malo ozungulira mjigo ndiwofunika kutchetcha/kukonzapo? <input type="checkbox"/> Pali udzu <input type="checkbox"/> Zinyasi komanso ndowe ya ziweto <input type="checkbox"/> Ndipakuda komanso pali ndere <input type="checkbox"/> Pali zithaphwi <input type="checkbox"/> Zina:			
2	Kodi pali chimbuzi pa mtunda wosakwana 30 mitazi?			
3	Kodi chimbuzi chapafupi chili kumtunda kwa Mjigo?			
4	Kodi pa malo ozungulira Mjigo pali zithu zilizonse zomwe zingachititse madzi kuonongeka? Ngati ndi eya, Ndichiyani? <input type="checkbox"/> Chimbuzi <input type="checkbox"/> Dzenje la zinyalala <input type="checkbox"/> Bafa <input type="checkbox"/> Cultivation <input type="checkbox"/> Khola la Ziweto <input type="checkbox"/> Zina:			
5	Kodi ngalande ya madzi apamjigo ili ndi vuto? (e.g., monga kusweka, ikulola kudikha madzi)?			
6	Kodi pamjigo pali mpanda umene umalola nyama kulowa?			
7	Kodi konkiriti yozungulira thunthu la mjigo ndi yochepera 1 mita?			
8	Kodi konkiriti ili ndi ming'alu ina iliyonse?			
9	Kodi thunthu la mjigo limagwadera kotero kuti madzi akhoza kulowa mbali mwake?			
10	Kodi konkiriti ndi apuloni yonse ndiyosangambika kapena kusweka?			

Zoyenera kuchita kuti tikonze vuto	Tsiku lomwe tigwire ntchitoyo	Wotsogolera	Ndalama zomwe zifunike

Chithunzi cha pansi cha Mjigo(Kuwonetsa mtunda wa malo amene muli zinthu zomwe zingachititse madzi apa Mjigo kuwonongeka)

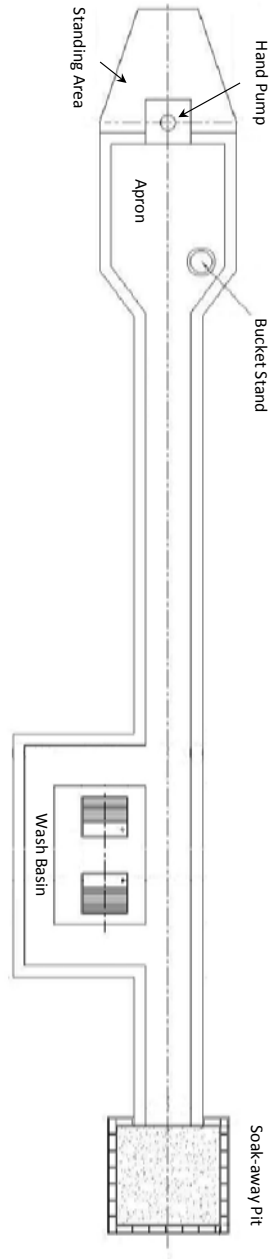

Tool 10

Visual Education Materials

Zithunzi zophunzitsira

1. A LATRINE NEAR A BOREHOLE AS SOURCE OF CONTAMINATION

S2

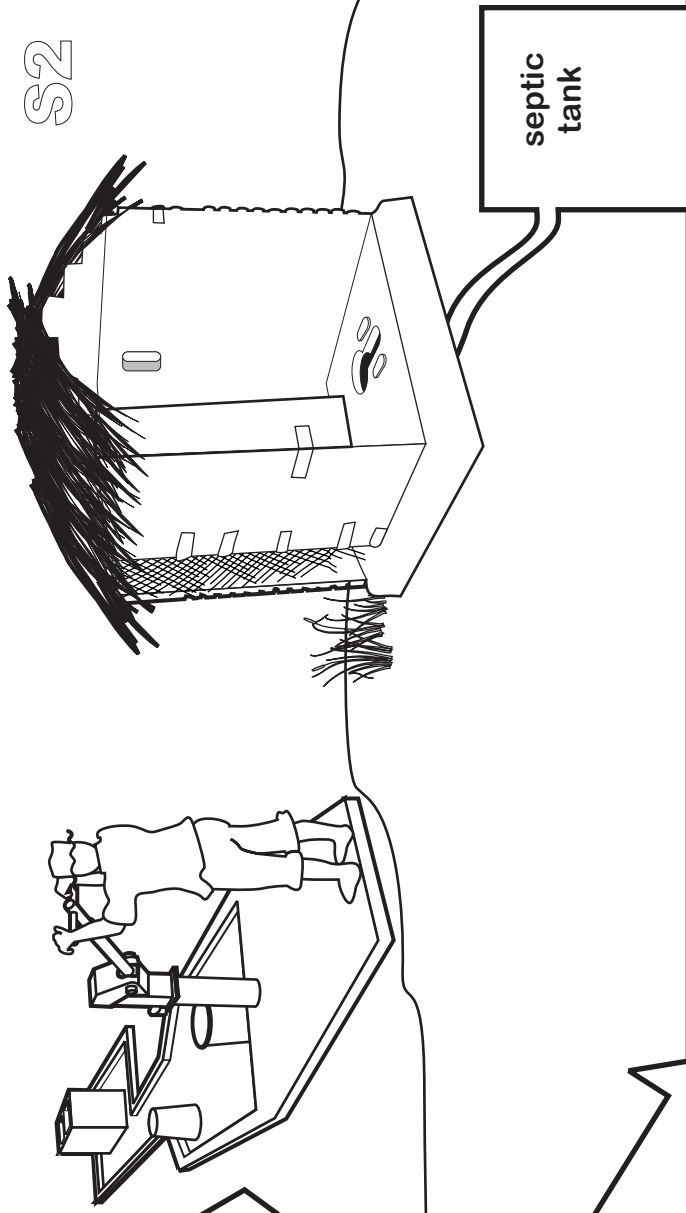

S3

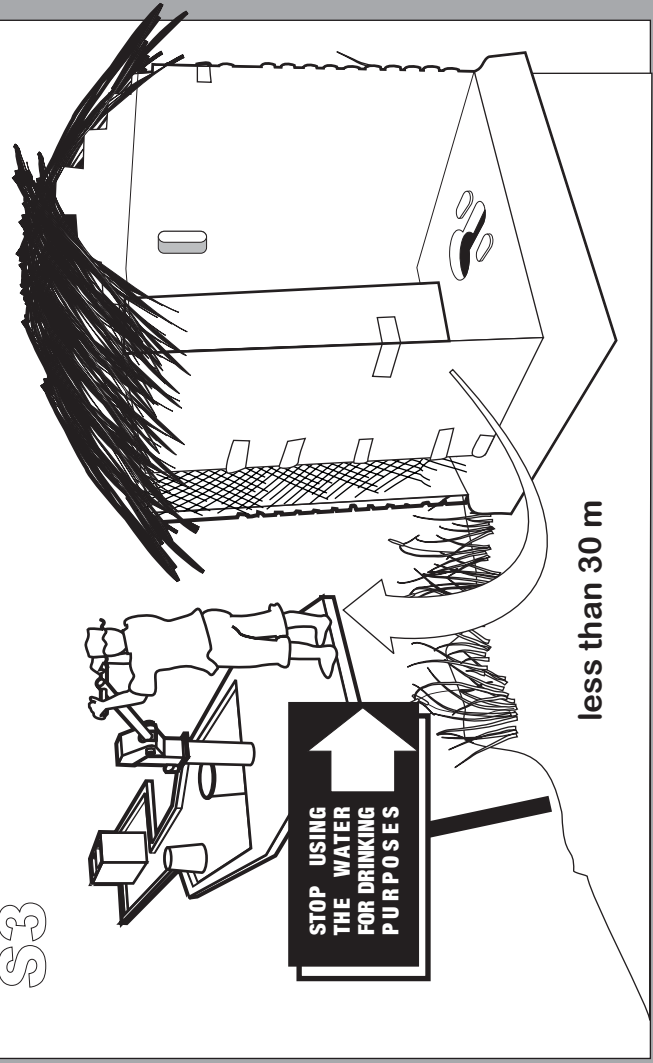

S1

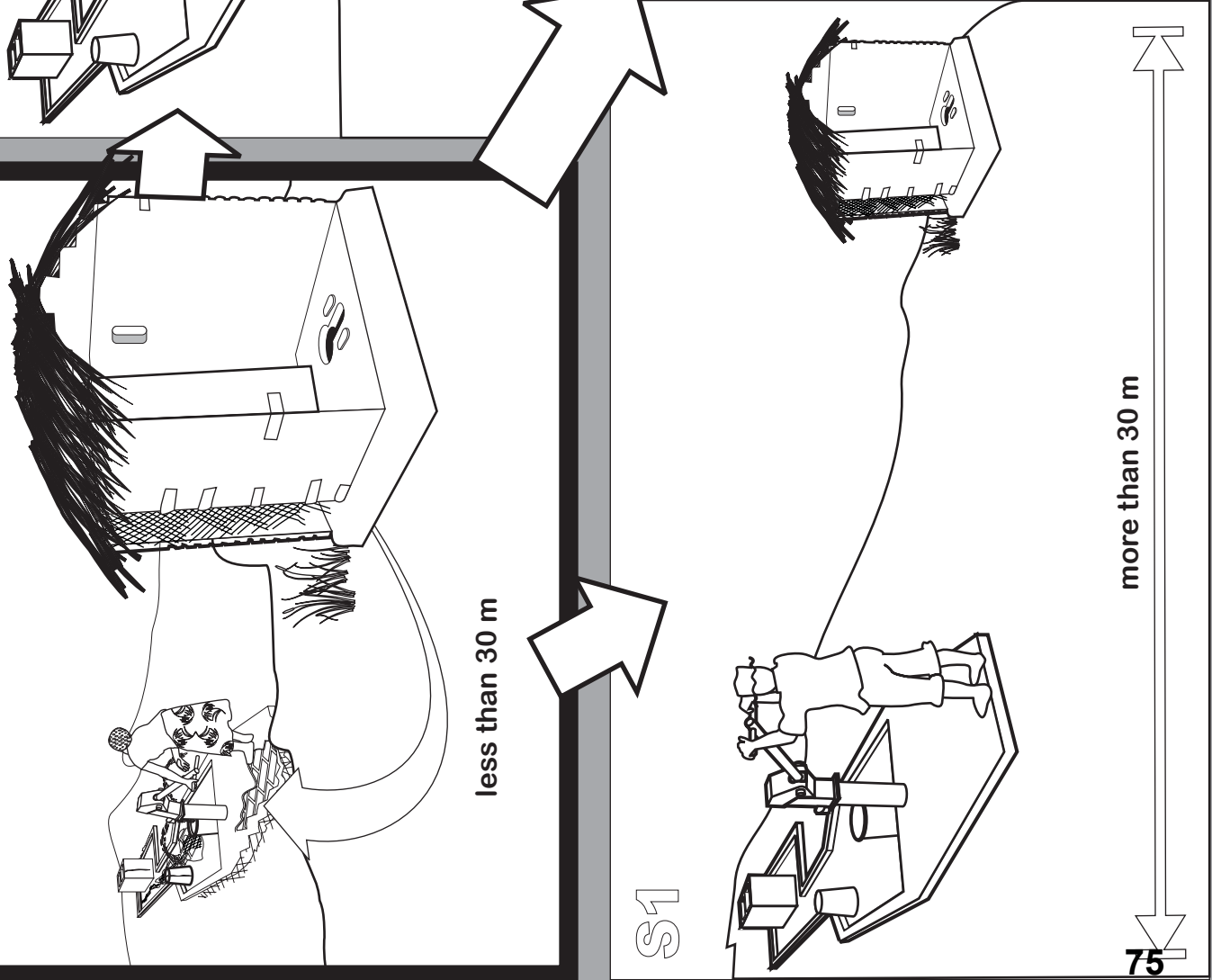

less than 30 m

more than 30 m

Material 1: A latrine near a borehole as source of contamination.

ENGLISH:

1. TITLE: A latrine near a borehole as source of contamination.
2. PROBLEMATIC SITUATION: Nearest latrine is less than 30 meters and is on higher ground than water point.
3. SOLUTION OR/AND DESIRABLE SITUATION
 - SOLUTION 1: Stop using the latrine and relocate it at a safe distance
 - SOLUTION 2: If latrine cannot be relocated, construct a latrine with a septic tank.
 - SOLUTION 3: If latrine cannot be relocated and septic tank cannot be constructed for any reason, the water point should be abandoned for drinking purpose.

CHICHEWA:

MJIGO OMWE ULI PAFUPI NDI CHIMBUDZI NDI GWELO LA MATENDA

Mavuto omwe angadze (kufotokozero)

Chimbudzi chomangidwa pafupi ndi Mjigo pa mtunda wochepera milingo makumi atatu kumtunda kwajigo.

ZOFUNIKA KUCHITA POTHETSA VUTOLI

Tisiye kugwiritsa ntchito chimbudzi ndi kuchimangira malo ena otalikirana ndi Mjigo wathu pamtunda opitilira milingo makumi atatu.

Ngati nyumba yachimbudzi singasamusedwe ndipofunika kukonza njira ndi kukumba dzenje kumusi kwa nyumba ya chimbudzi Ngati chimbudzi chitalephere kusamusedwa ndipo njira yokumba chimbudzi cha madzi italephelekanso madziwo asamwedwe.

2. POSSIBLE POLLUTANTS NEAR THE BOREHOLE AS SOURCE OF CONTAMINATION

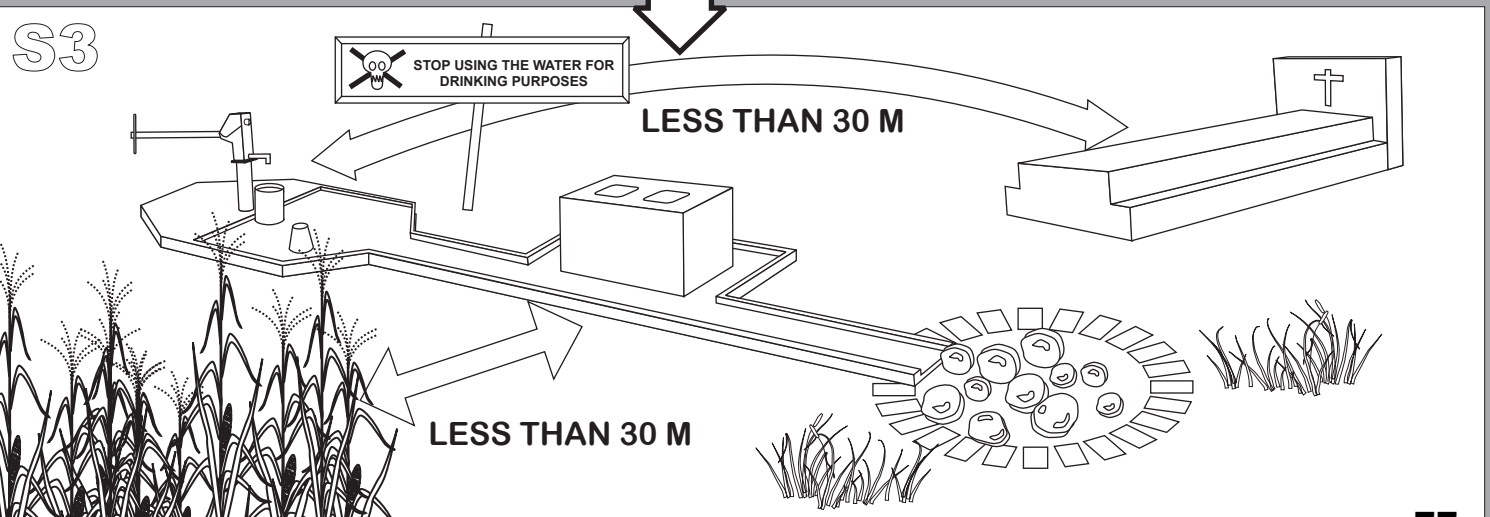
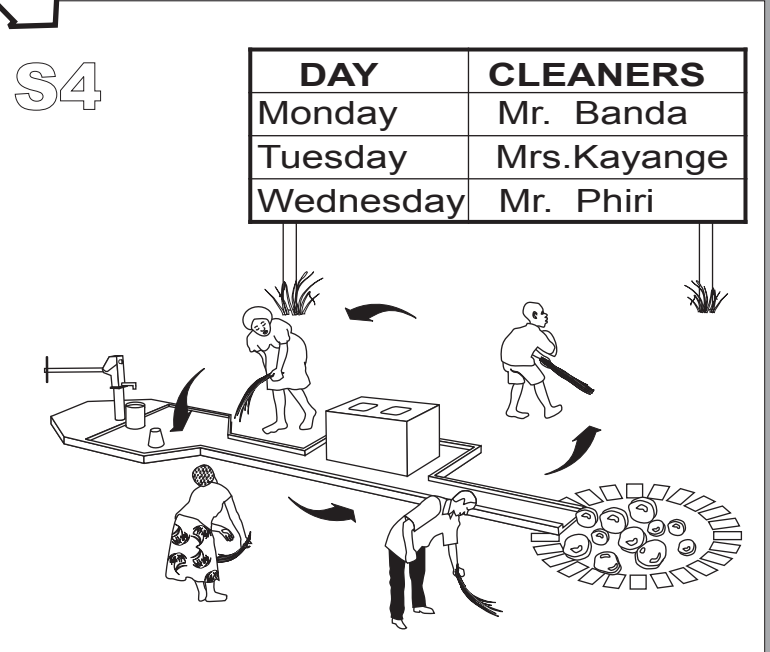
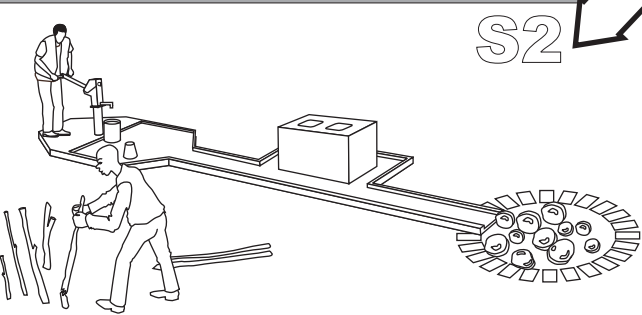
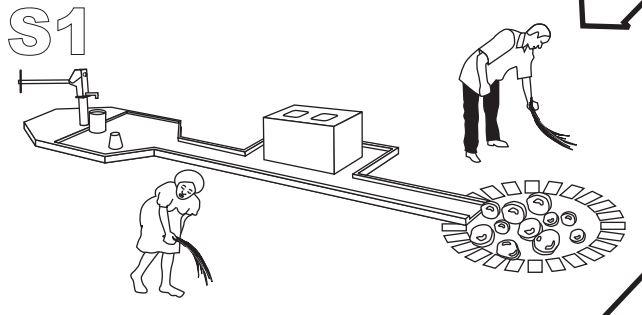
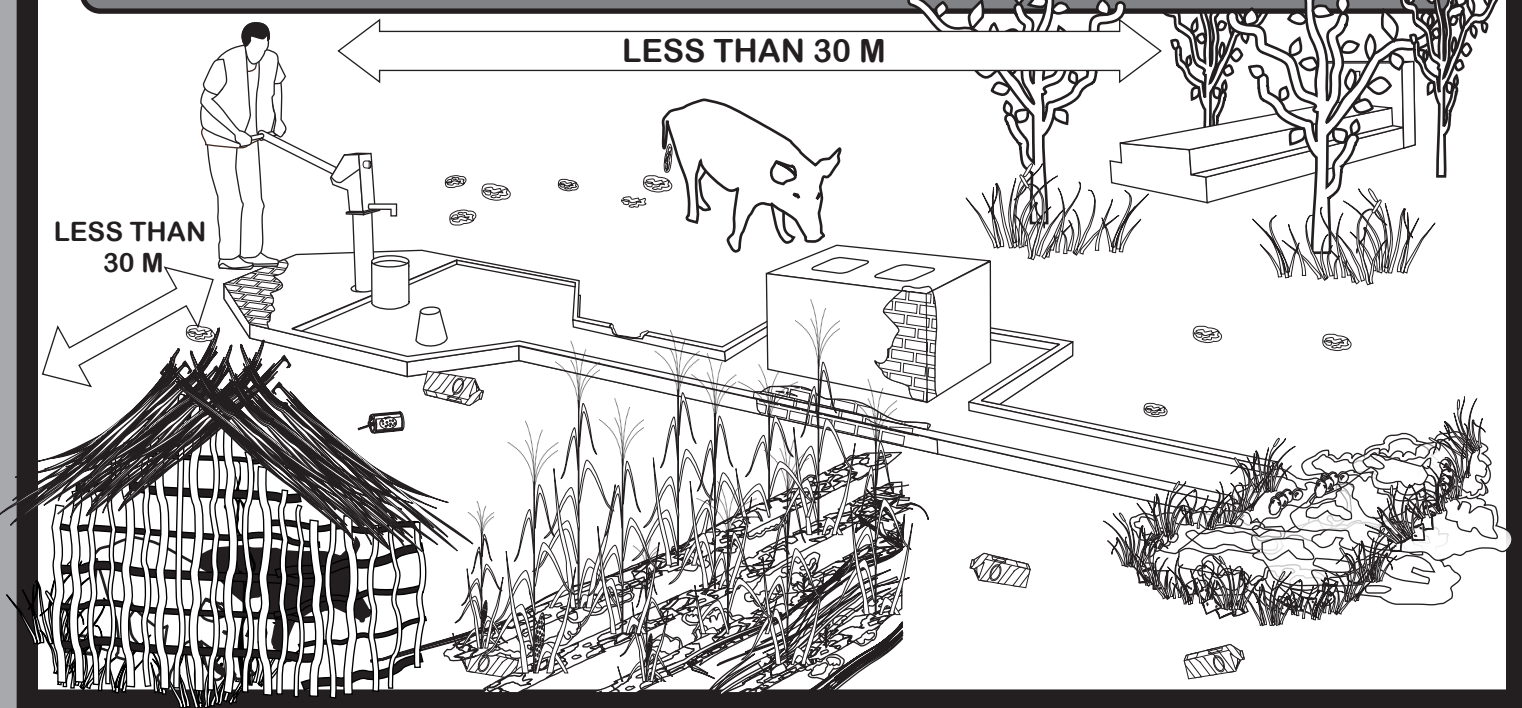

Material 2: Possible pollutants near the borehole as source of contamination

ENGLISH:

1. TITLE: Possible pollutants near the borehole as source of contamination.
2. PROBLEMATIC SITUATION: The sources of pollution (such as rubbish dumps, animal cage, feces, grazing, grave yard, cultivation) are less than 30 meters
3. SOLUTION OR/AND DESIRABLE SITUATION
 - SOLUTION 1: Clean the rubbish dumps.
 - SOLUTION 2: Remove animal cage, animal dung, grazing around the hand pump.
 - SOLUTION 3: If the water points are near grave yard and cultivation is taking place, the water point should be abandoned for drinking purpose.
 - SOLUTION 4: Make roster among users to clean surrounding and platform.

CHICHEWA:

KAMANGIDWE KA APULONI KOMWE KANGABWERETSE CHIOPYSEZO PA DILAWO PATHU CHOMWE CHINGABWERETSE BVUTO

Ngati apuloni yathu ichepa ndi 1 meter kuzungulira Mjigo /dilawo yathu.

Komanso ngati popondera pojiga pachepa ndi mamita atatu, kuchokera pa Mjigo/dilawo kapena Apuloni yathu yasweka, kapena ili ndi ming'alu ndi maenje

NJIRA YOTHETSERA VUTO

Mangani Apuloni yatsopano yotalika ndi meter imodzi kapena kuposera apo, ndi popondera pojiga patalike ndi mamita atatu kapena kuposera apo.

Mothandizidwa ndi a makaniki ndi a misiri a m'mudzi ngati palibe ena.

3. CONCRETE APRON DEFECTS THAT MAY POSE A THREAT TO THE BOREHOLE

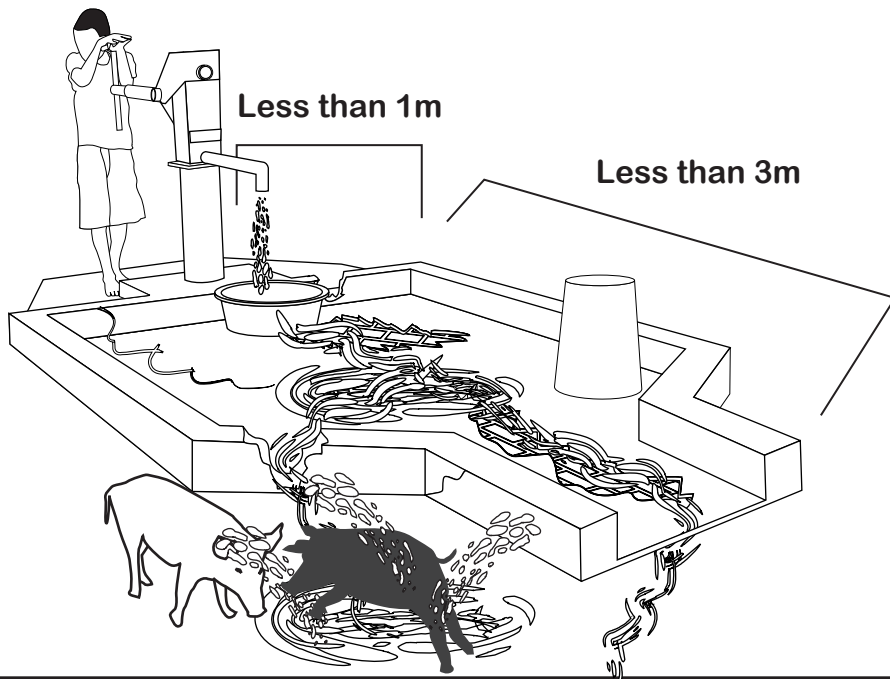

S1

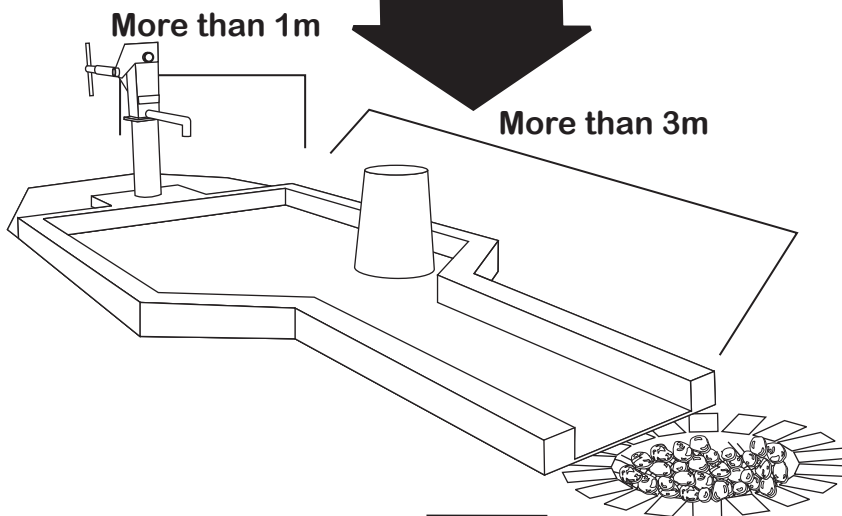

OR

S2

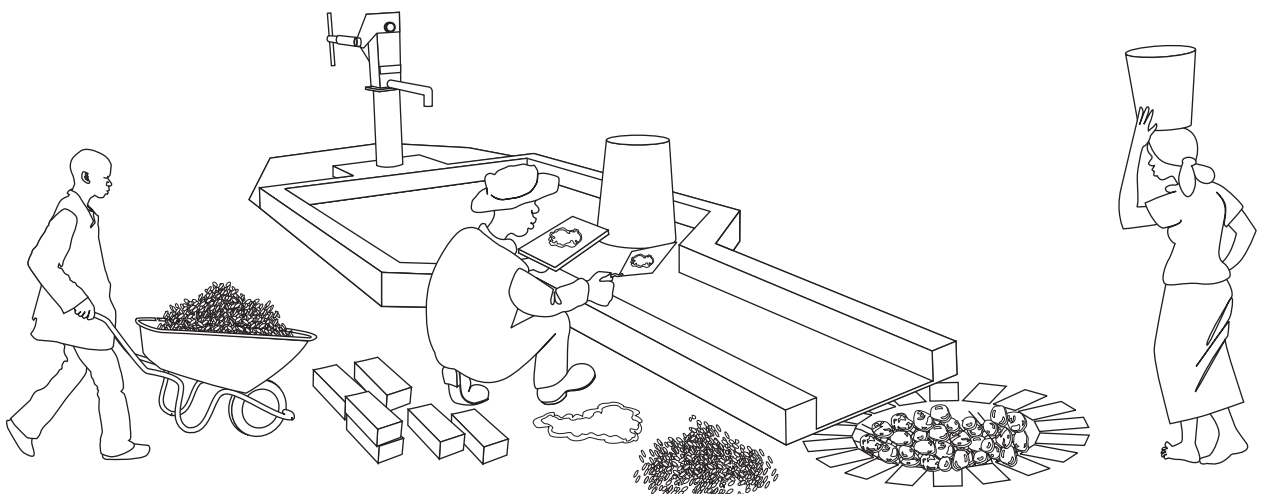

Material 3: Concrete apron defects that may pose a threat to the borehole

ENGLISH:

1. TITLE: Concrete apron defects that may pose a threat to the borehole.
2. PROBLEMATIC SITUATION: Concrete apron is less than 1 meter around the pump stand and with less than 3 meters of concrete sanitary protection with borehole or the concrete apron is broken, cracks and potholes.
3. SOLUTION OR/AND DESIRABLE SITUATION
 - SOLUTION 1: Construct a new apron with 1 meter or more long and sanitary protection with 3 meters more long with the support of Area Mechanics and Village Builders.
 - SOLUTION 2: Repair existing apron to remove cracks and potholes and improve slope towards drainage.

CHICHEWA:

KAMANGIDWE KA APULONI KOMWE KANGABWELETSE CHIOPYSEZO PA DILAWO PATHU CHOMWE CHINGABWERETSE VUTO

Ngati apuloni yathu ichepa ndi I meter kuzungulira Mjigo /dilawo yathu. Komanso ngati popondera pojiga pachepa ndi milingo itatu kuchokera pa mjigo kapeana Apuloni yathu yasweka , kapena ili ndi mingálu ndi maenje.

NJIRA YOTHETSERÁ VUTO

Mangani Apuloni yatsopano yotalika ndi mulingo r umodzi kapena kuposera apo, ndi popondera pojiga patalike ndi milingo itatu kapena kuposera apo.Mothandizidwa ndi amakaniki ndi a womanga a mmudzi ngati palibe.

4. STAGNANT WATER NEAR THE BOREHOLE AS A SOURCE OF CONTAMINATION

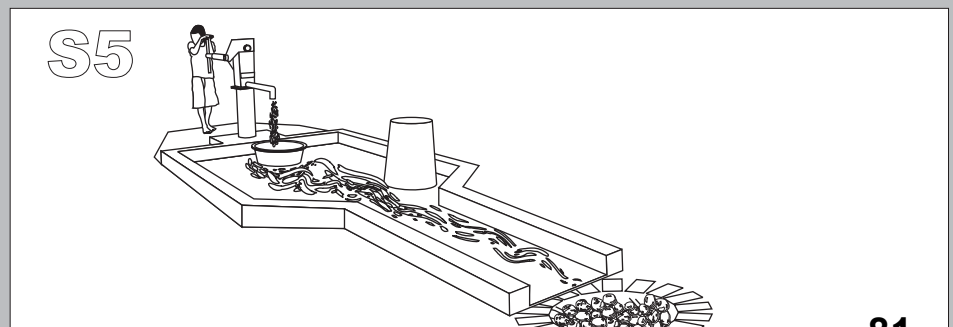
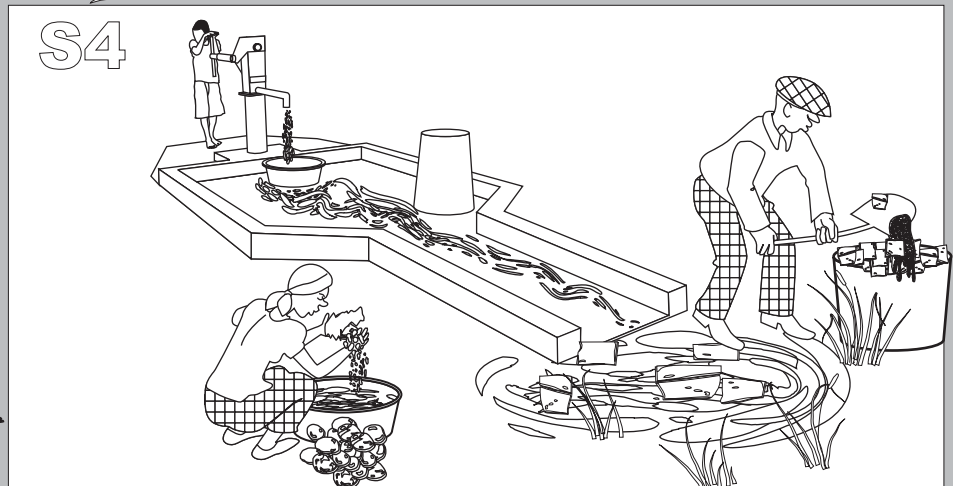
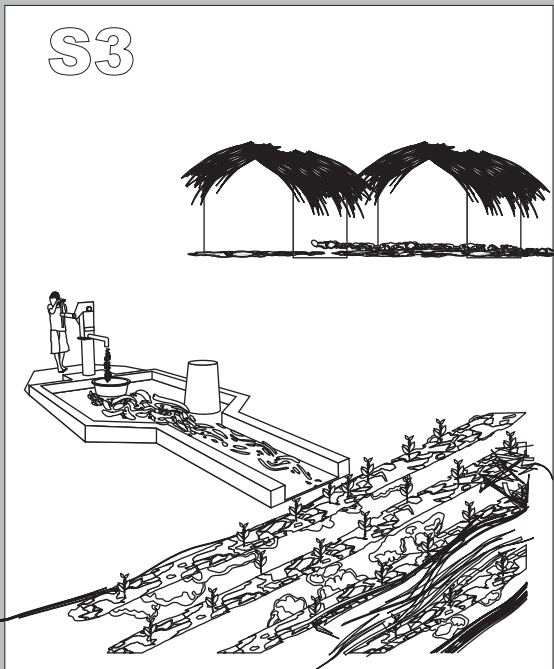
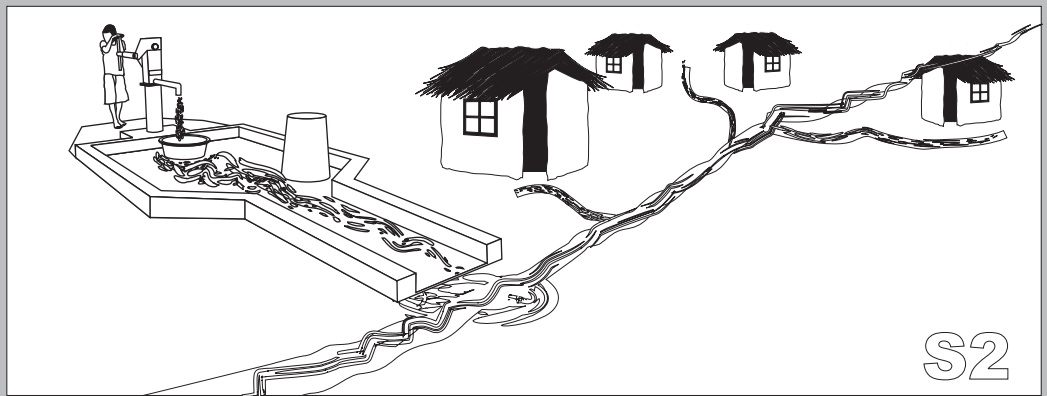
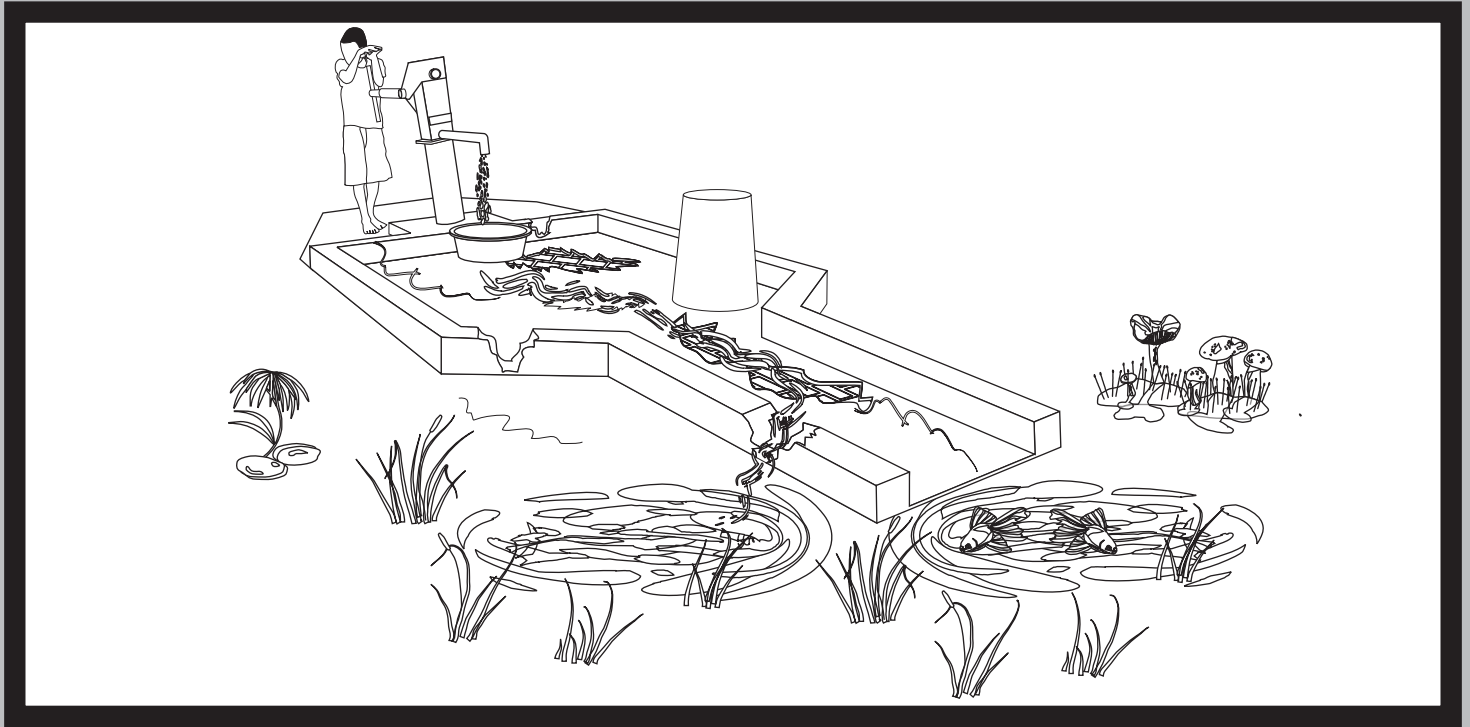

Material 4: Stagnant water near the borehole as a source of contamination

ENGLISH:

1. TITLE: Stagnant water near the borehole as a source of contamination.
2. PROBLEMATIC SITUATION: Stagnant water sources (pool of water from soak away pits, improper drainage and fish/ duck ponds) are less than 30 meters from water points.
3. SOLUTION OR/AND DESIRABLE SITUATION
 - SOLUTION 1: Use funnels when jerry can with small mouths are being used to avoid spill over that can enhance the pool of water, waste water to be minimized.
 - SOLUTION 2: Improve drainage so that waste water flows into natural drainage.
 - SOLUTION 3: Develop vegetable garden using waste water.
 - SOLUTION 4: Remove litter and wash stones in a soak away pit.
 - SOLUTION 5: Divert the direction of the soak away pit and drain off the pool of water.

CHICHEWA:

ZITHAPHWI ZOYANDIKANA NDI MJIGO MOMWE ZINGAONONGELE MADZI

Mabvuto ake: Momwe zithaphwi zimabwelera

Kutayikira kwa madzi a Mngalande, njira yolakwika yochotsera madzi otayikira pa mjigo ndinso kupezeka kwa maenje a nsomba ndi a bakha malipande osachepera maku atatu kuchokera pa mjigo. **NJIRA ZOTHETSERA / NJIRA ZOBVOMEREZEKA**

Njira yoyamba

Kugwiritsa ntchito fanulo potunga madzi mzigubu zakukamwa kochepe

Njira ya Chiwiri

Kukonza njira zabwino zoti madzi adzilowa moyendera

Njira ya Chitatu

Kulimapo Dimba pogwiritsa ntchito madzi otaikira

Njira ya Chinayi

Kuchotsa zinyalala, kutsuka miyala ndi kukapa dzenje.

Njira ya Chisanu

Kupatutsa njira yodutsa madzi ndi Cholinga chokapa dzenje

5. DEFECTS OF CONCRETE

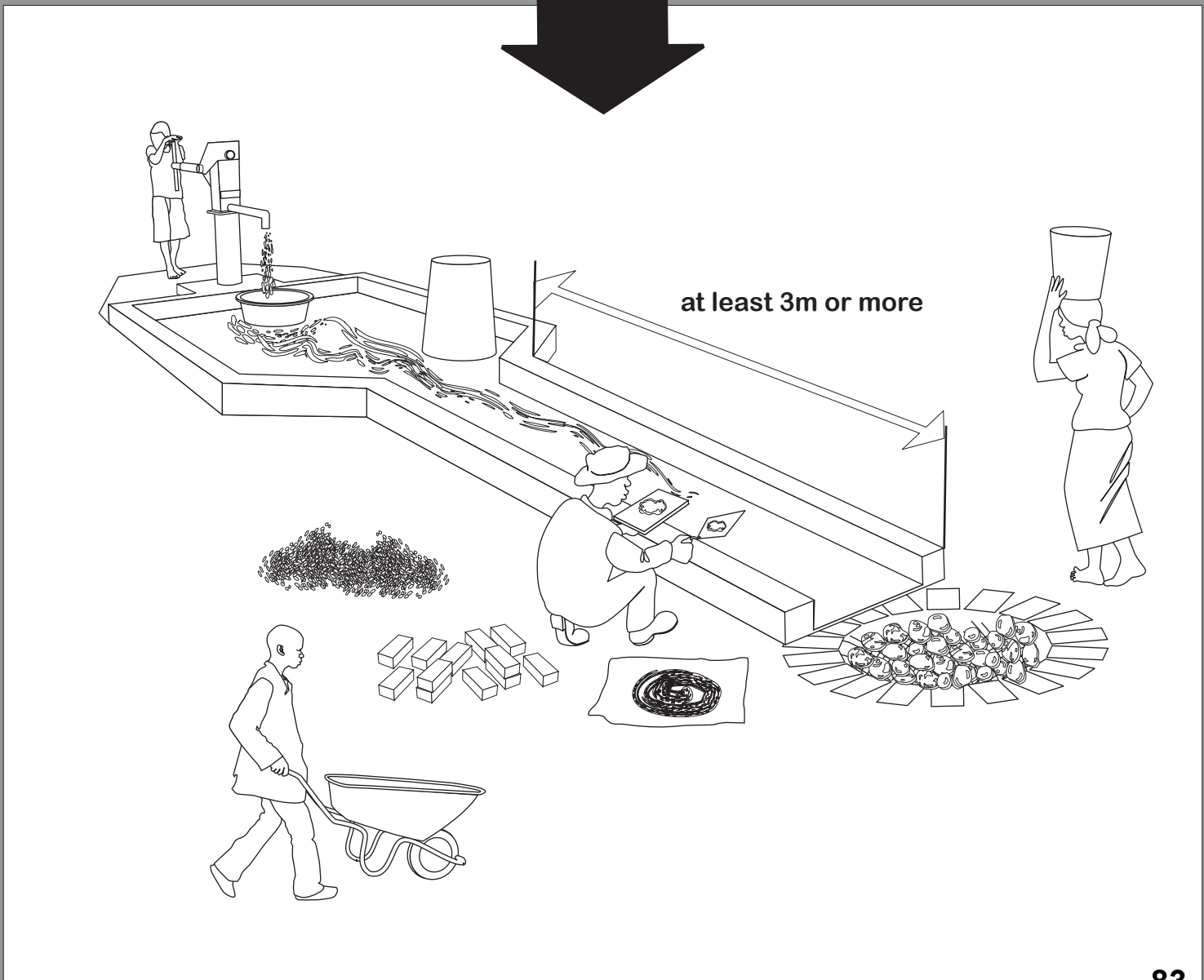
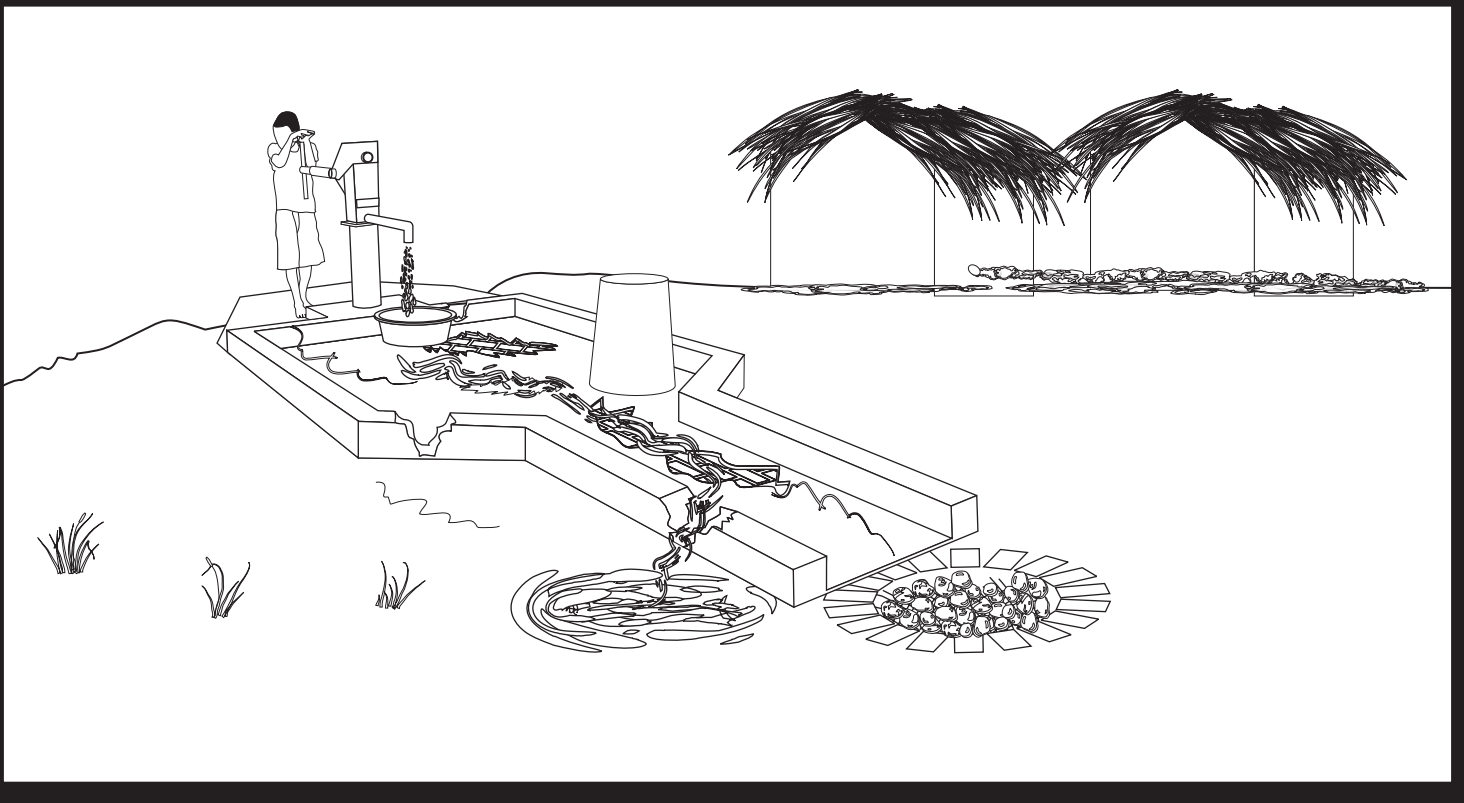

Material 5: Defects of concrete

ENGLISH:

1. TITLE: Defects of concrete
2. PROBLEMATIC SITUATION: Concrete drainage channel attached to apron is less than 3 meters long ending into a soak away pit or vegetable garden.
3. SOLUTION OR/AND DESIRABLE SITUATION
 - SOLUTION 1: Improve natural drainage by lengthening it up to at least 3 meters or more or mobilize resources and extend drainage channel to at least 3 meters.

CHICHEWA:

Kuonongeka kwa konkileti pa Mjigo

VUTO:

Ngalande inapwanyikapwanyika

Ngalande ndi Yayifupi ndipo madzi amatulukira pambali

Madzi adekha pa mjigo

KUKONZA VUTO

Timange ngalande yaitali, malipande osachepela atatu

Tipeze njira yopezera zipangizo zoti tikonzere ngalande yaitali ndi malo onsewonongeka pa mjigo monga kukwilira mayenje onse

6. DEFECTS OF APRON AND DRAINAGE CHANNEL

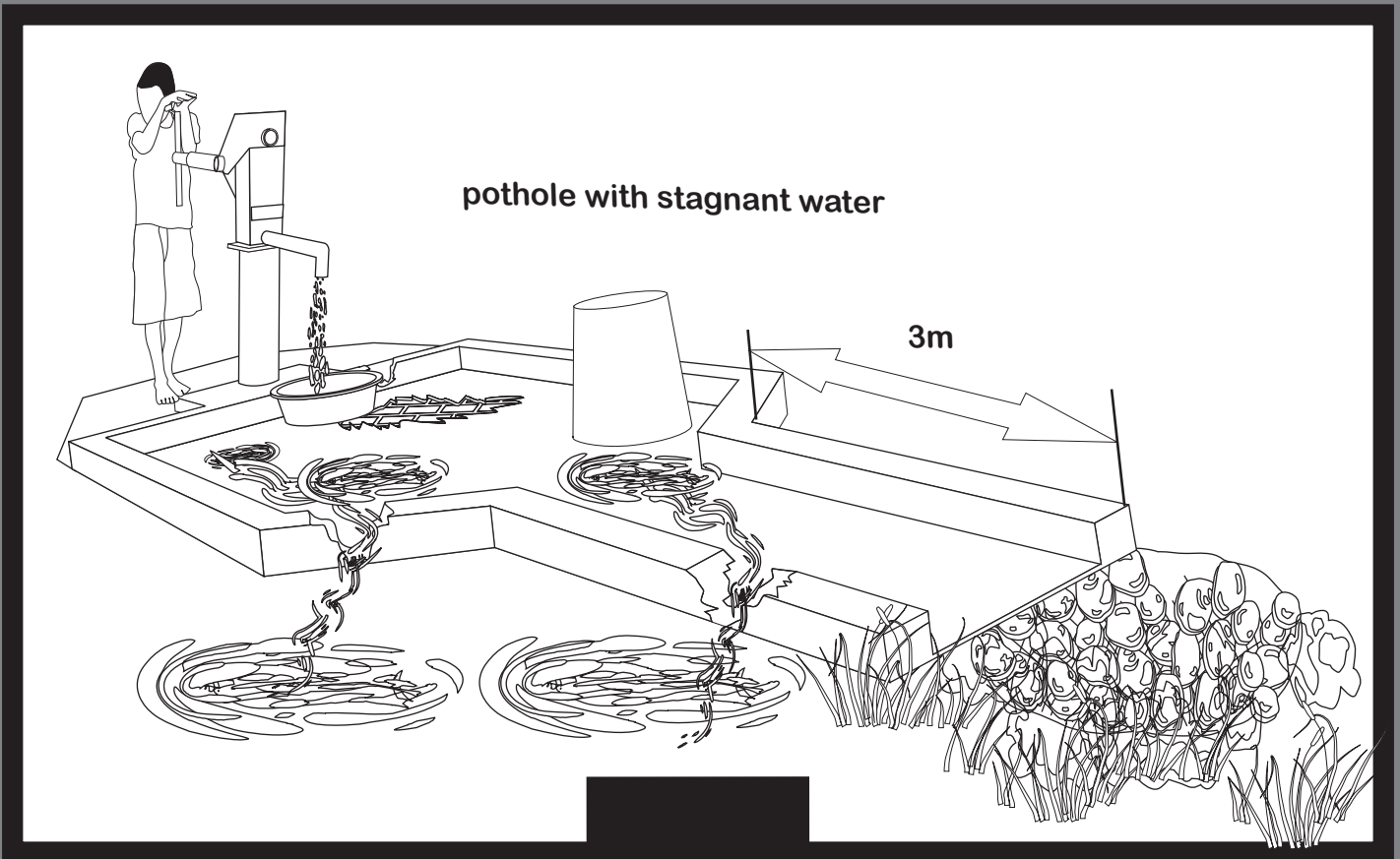

Material 6: Defects of apron and drainage channel

ENGLISH:

1. TITLE: Defects of apron and drainage channel
2. PROBLEMATIC SITUATION: Apron and 3 meters long drainage channel has cracks and pot holes with stagnant water.
3. SOLUTION OR/AND DESIRABLE SITUATION
 - SOLUTION 1: Mobilize resources and repair the drainage and the slope of the channel.

CHICHEWA:

KUSWEKA / KUWONONGEKA KWA APOLONI NDI NGALANDE YOYENDAMO MADZI

VUTO

Kusweka kwa apoloni ndi ngalande yoyendamo madzi ndi mayenje modikha madzi

KUKONZA KUTHETSA VUTO

Kupeza zipangizo zokonzera Apoloni ndi Ngalande yoyendamo madzi monga izi:-
Simenti - Njerwa - Mchenga – Miyala – Wilibala – Makasu – Madzi ndi anthu ogwira ntchito ndi kukonza ngalande ya madzi wotayikirawo.

7. UNHYGIENIC ENVIRONMENT AT A BOREHOLE SURROUNDING

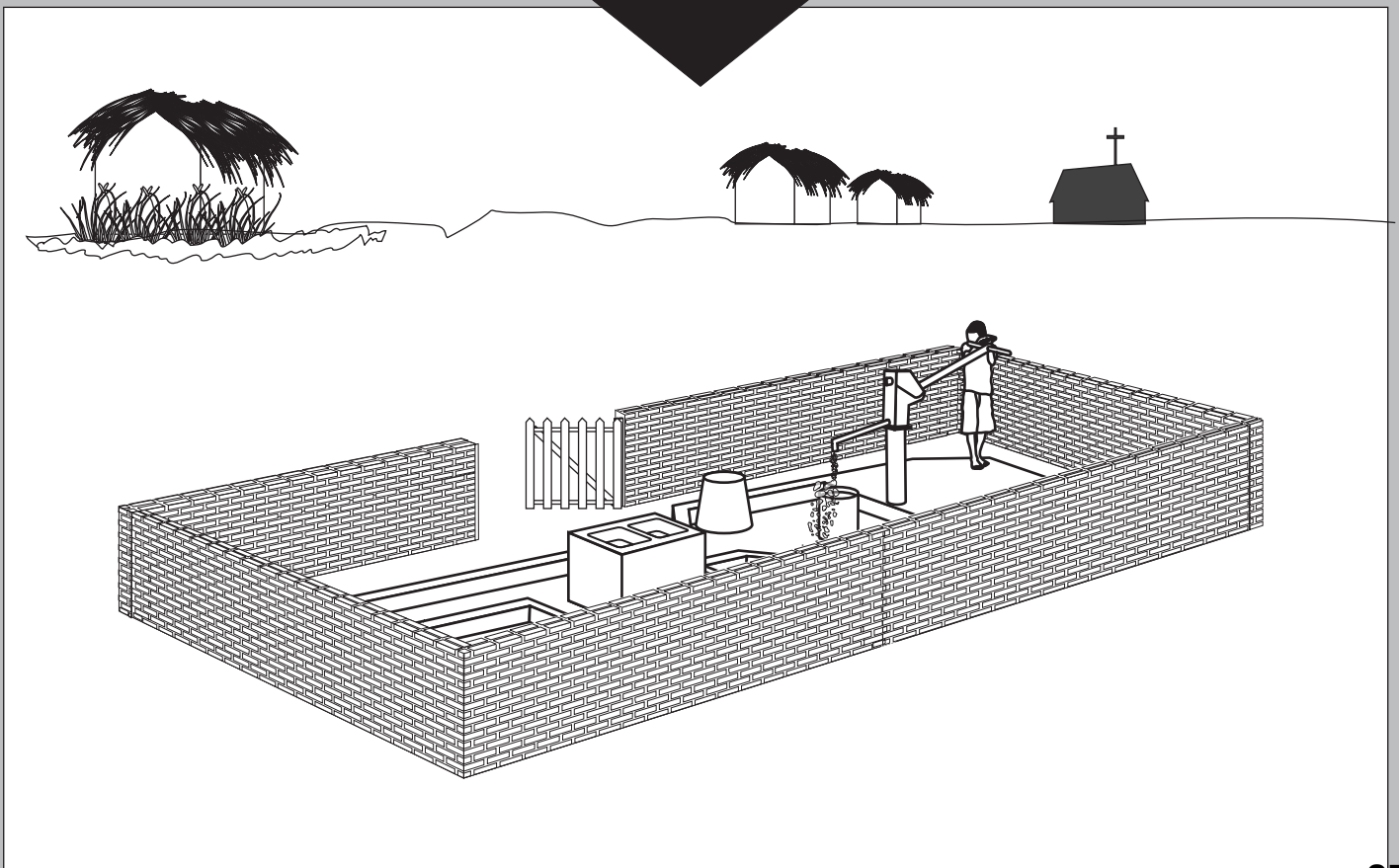
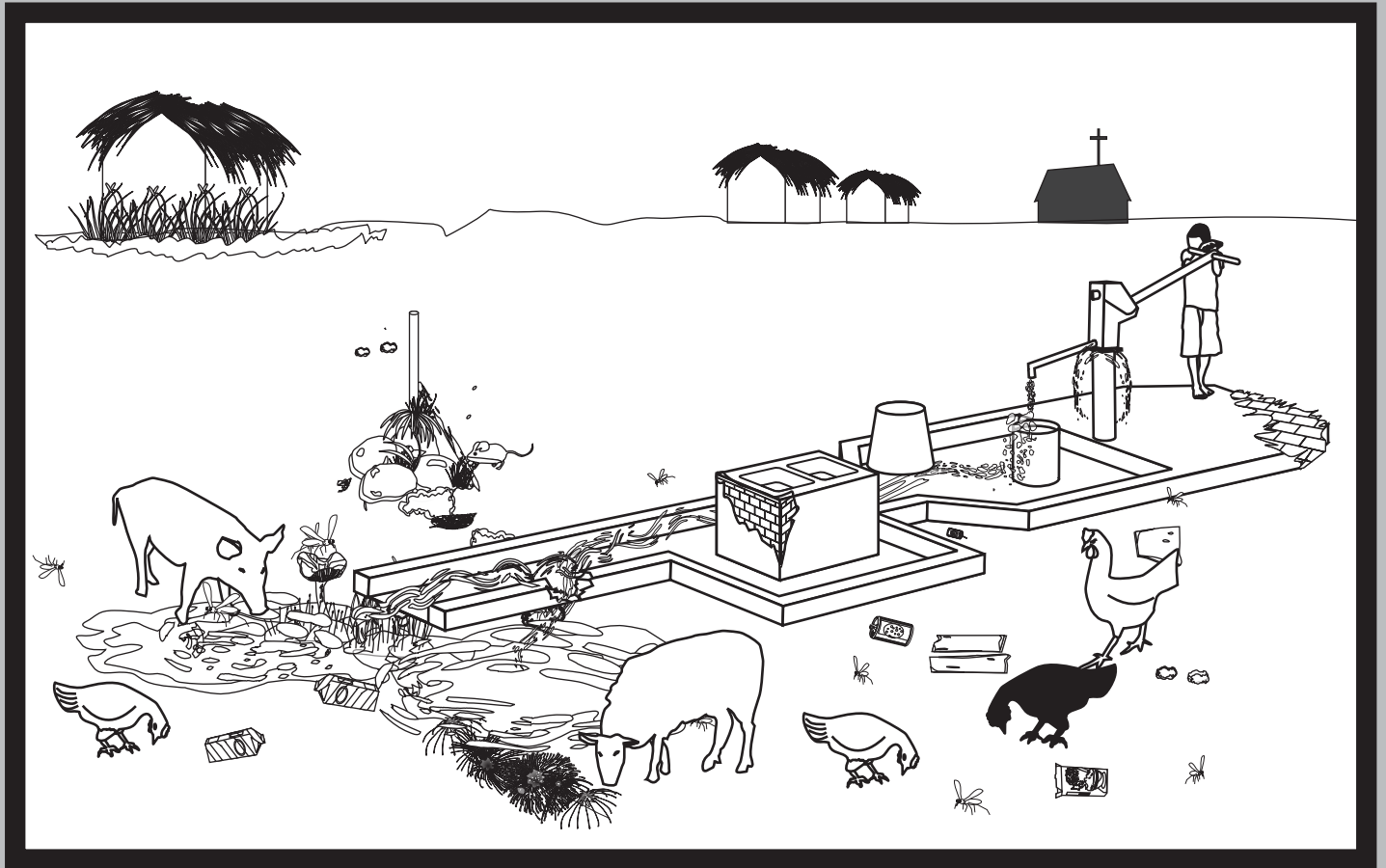

Material 7: Unhygienic environment at a borehole surrounding

ENGLISH:

1. TITLE: Unhygienic environment at a borehole surrounding
2. PROBLEMATIC SITUATION: General surrounding of a borehole is unhygienic (borehole untidy / dirty grown up grasses, shrubs/ vegetation).
3. SOLUTION OR/AND DESIRABLE SITUATION
 - SOLUTION 1: A tidy / clean borehole surrounding.

CHICHEWA

UMVE PA MALO OZUNGULIRA MJIGO ZOTSATIRA ZAKUSASAMALA PA MJIGO (MAVUTO)

Malo ozungulira pa mjigo amakhala osasesedwa, osalambulidwa komanso osatchatchedwa

ZOYENERA KUCHITA /ZOYEMBEKEZERA

Malo a mjigo akhale osesedwa okolopedwa, olambulidwa, okhala ndi mpanda komanso dzenje logwelamo MadziMadzi.

CHITHUNZI CHOYAMBA

Palibe dzenje logweramo madzi

Palibe mpanda

Posasesedwa / kulambulidwa

Pali ziweto

Mjigo womasuka (ma bouti)

Mjigo wosasamalidwa

Tool 11

Informed Choice Booklet for Water Point Sanitation (Afridev Handpump Version)

Buku lothandiza kusankha m'mene tingachitire ukhondo pa mjigo wa mtundu wa Afridev.

F1: Mpanda wa Tsekera

Kuyelekeza mtengo:

21,000 MK (mwezi wa September 2014)

Ubwino	Kuyipa kwake
<ul style="list-style-type: none"> 100 peresenti zipangizo zake ndi zakumudzi Sumalemera Sumavuta kumanga Ndiwotsika mtengo Zipangizo zake zimapezeka kumudzi. 	<ul style="list-style-type: none"> Sumakhalitsa, ndiponso umafuna kukonza chaka ndi chaka Ndiwosalimba Chiswe chitha kudya tsekera Anthu atha kuyatsa moto

Zipangizo [Chitsanzo]

(L x B x H = 15m x 3m x 1.2m)

- Tsekera: Mito 25
- Khonje: Mipukutu 30
- Mitengo: Yokwana 10
- Nsungwi: Zokwana 10
- Linya: Mipukutu 100

Zida

- Chikwanje: Chimodzi
- Khasu: Limodzi
- Mpeni: Umodzi

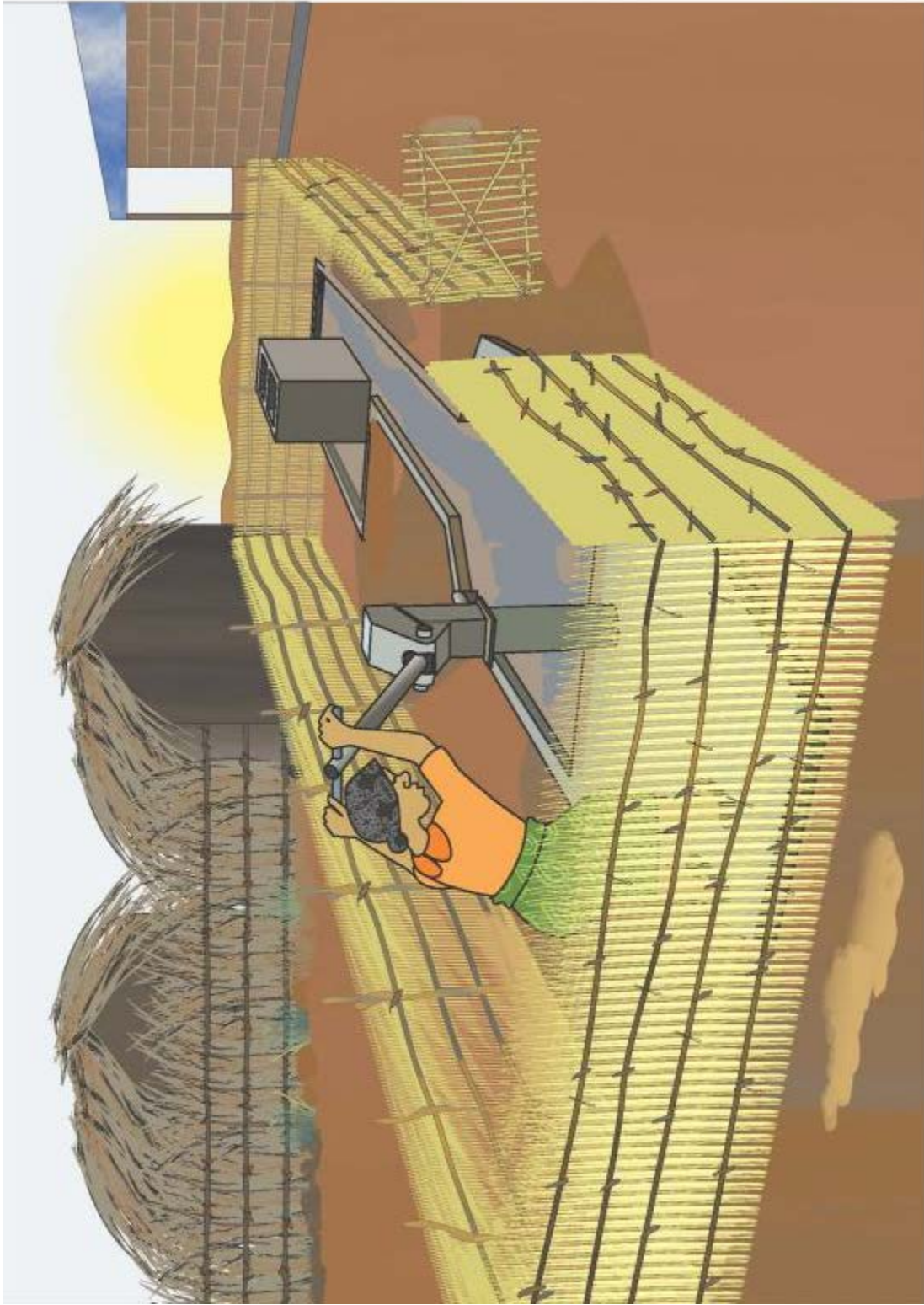

F2: Mpanda wa thabwa

Kuyelekeza mtengo:

36,000 MK (M'mwezi wa September 2014)

Ubwino	Kuyipa kwake
<ul style="list-style-type: none"> 100 peresenti zipangizo zake zimapezeka zakumudzi Sumavuta kumanga Ndiwontsika mtengo Sumavuta kukonzanso Mutha kusitha maonekedwe 	<ul style="list-style-type: none"> Umafuna kukonza chaka chaka ndi kuti udziwoneka bwino Matabwa amatha kuwonongeka ngati sanathiridwe makhwala Chiswe chitha kuwononga Anthu atha kuyasa

Zipangizo [Chitsanzol], (L x B x H = 15m x 3m x 1.2m)

- Matabwa: okwana 15
- Misomali: 2 Kilo
- Makhwala achiswe: 5lita

Zida

- Hamala: Imodzi
- Chikwanje: Chimodzi
- Khasu: Limodzi



F3: Mpanda wa Nsungwi

Kuyelekeza mtengo:
13,000 MK (M'mwezi wa September 2014)

Ubwino	Kuyipa kwake
<ul style="list-style-type: none"> 100 peresenti zipangizo zake zimapezeka zakumudzi Sumavuta kukonzanso Zipangizo zake zimapezeka kumudzi. Ndiwotsika Mtengo 	<ul style="list-style-type: none"> Umafuna kukonza chaka ndi chaka kuti udziwoneka bwino Nsungwi zimathakufumba ngati sizinathiridwe makhwala Chiswe chitha kuwononga atha kuyasa

Zipangizo [Chitsanzo]
(L x B x H =15m x 3m x 1.2m)

- Nsungwi: Mapisi okwana 40
- Khonje: Mipukutu 20
- Linya: Mipukutu 15
- Mitengo: Yokwana 10

Zida

- Chikwanje: Chimodzi
- Khasu: Limodzi
- Mpeni: Umodzi



F4: Mpanda wa zomera(Maluwa)

Kuyelekeza mtengo:
70,000 MK (M'mwezi wa September 2014)

Ubwino	Kuyipa kwake
<ul style="list-style-type: none"> 100 peresenti zipangizo zake zimapezeka kumudzi Sumawononga chilengwedwe Utha kukhala ndi mitundu yosiyanasinya pamodzi Umakhala wokongola 	<ul style="list-style-type: none"> Umafuna kukonza chaka ndi chaka kuti udziwoneka bwino Kugula maluwawa m'mudzi ndikovuta chifukwa samapezeka Simaluwa onse amene sangadyedwe ndi chiswe

Zipangizo [Chitsanzo] (L x B x H =15m x 3m x 1.2m)
<ul style="list-style-type: none"> Maluwa: Mapisi 84 Mitengo: Mapisi 10 Manyowa: Matumba 4 a 50kg Feteleza: 25kilogramu Misomali: 1 kilogramu

Zida
<ul style="list-style-type: none"> Chikwanje: Chimodzi Khasu: Limodzi Mpeni: Umodzi

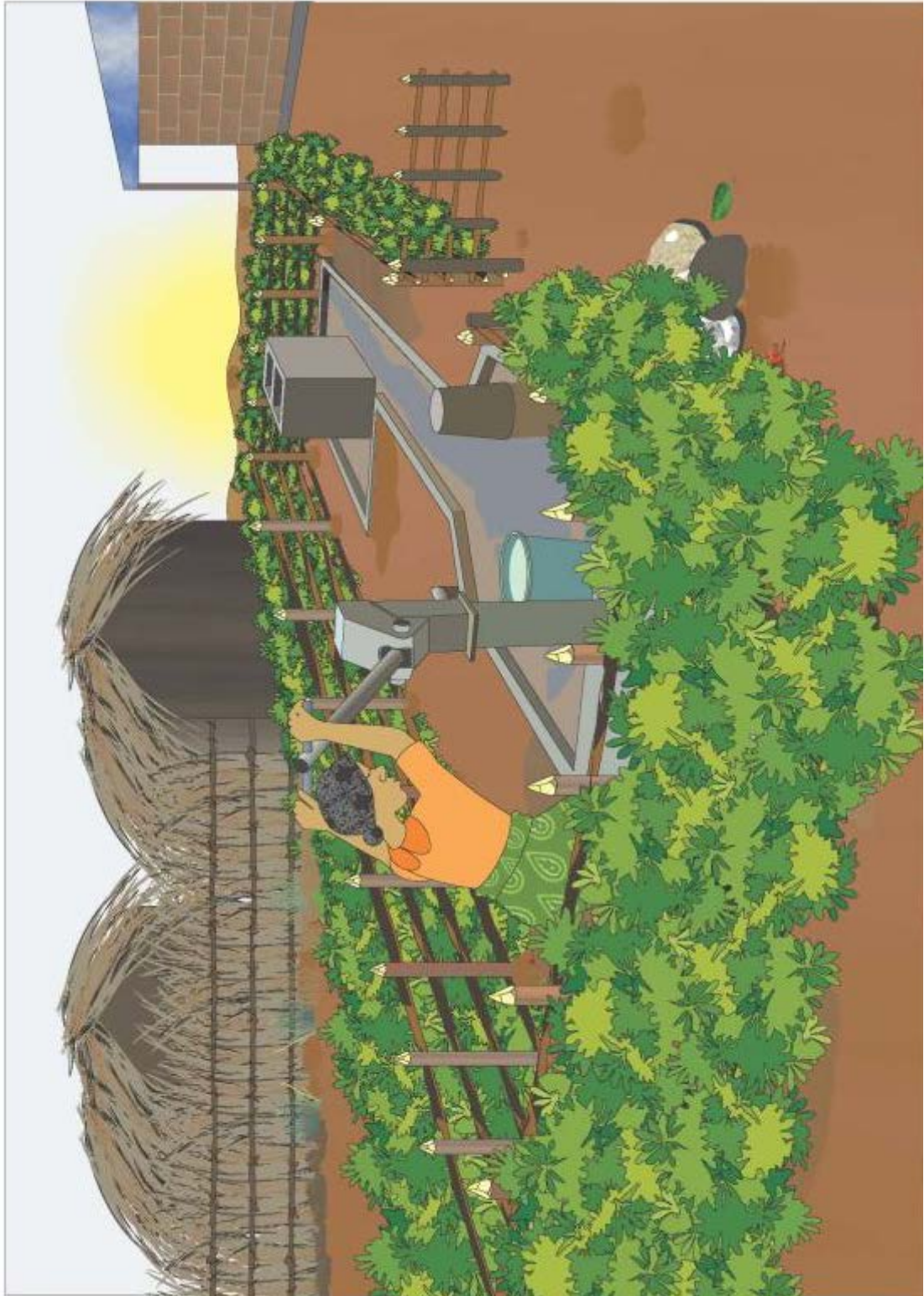

F5: Mpanda wa njerwa

Kuyelekeza mtengo:
73,000 MK (M'mwezi wa September 2014)

Ubwino	Kuyipa kwake
<ul style="list-style-type: none"> • Ndiwolimba • Sumafuna kukonzakon za 	<ul style="list-style-type: none"> • Ndiwokwera mtengo kuposa wa udzu, wa matabwa ndi nsungwi • Utha kugwa ngati sunamangwidwe bwino(Komanso ngati mchenga ndi simenti simunasakanize bwino utha kugwa)

Zipangizo [Chitsanzo]
(L x B x H =15m x 3m x 1.2m)

- Njerwa: Zokwana 1650
- Simenti: Matumba 6 a 50kg
- Mchenga: Ngolo ziwiri
- Matabwa: Mapisi awili

Zida

- Mpeni womangira: 1 Umodzi
- Levulo: 1 Imodzi
- Wilibala:1 Imodzi
- Shovel:1 Imodzi

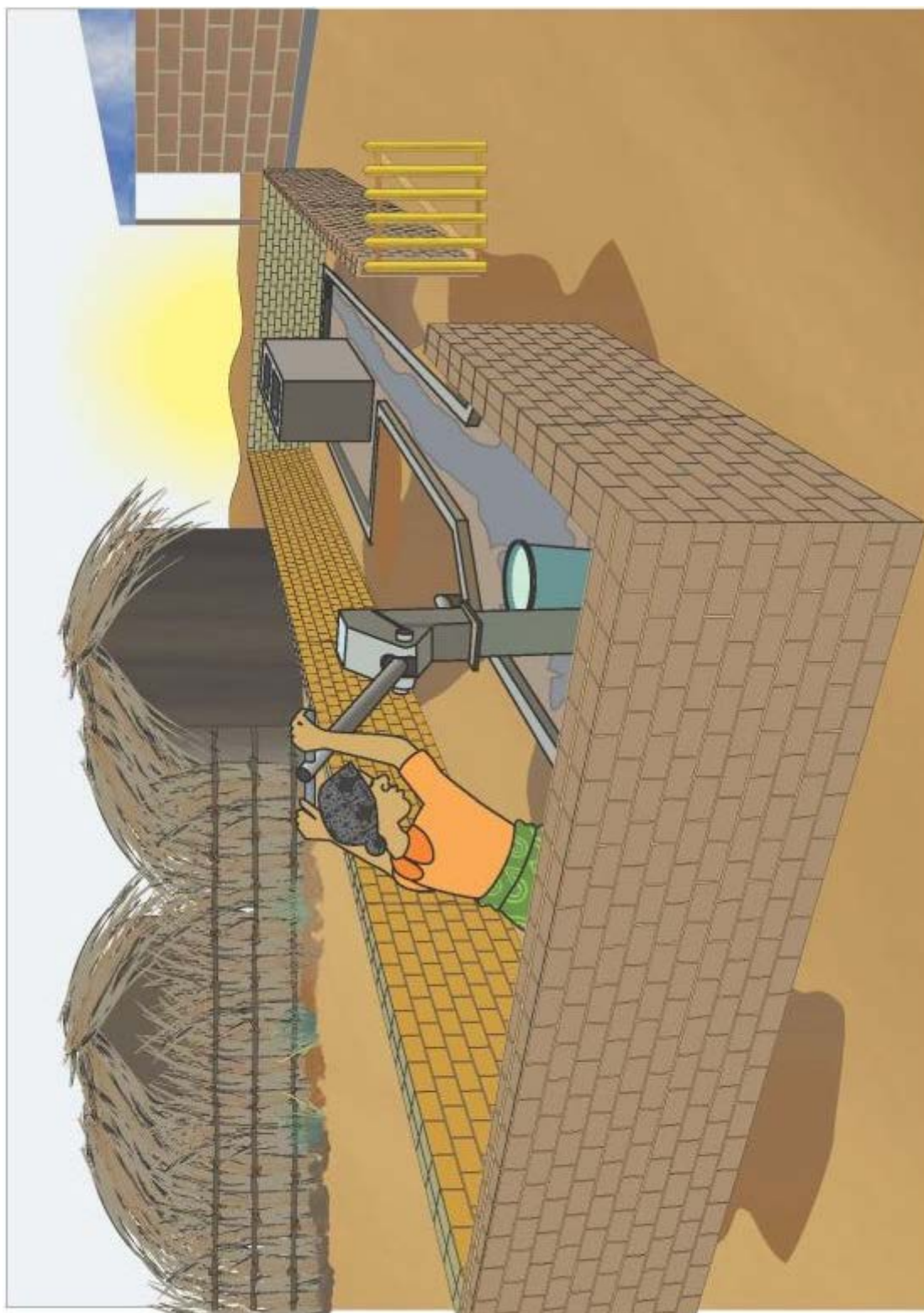

F6: Mpanda wa njerwa ndi pulasitala

Kuyelekeza mtengo:

90,000 MK (M'mwezi wa September 2014)

Ubwino

- Ndiwolimba
- Sumafuna konzakonza

Kuyipa kwake

- Ndwokwera mtengo kuposa wa udzu, wa matabwa ndi nsungwi
- Utha kugwa ngati sunamangwidwe bwino (Komanso ngati mchenga ndi simenti simunasakanize bwino)

Zipangizo [Chitsanzol]

(L x B x H = 15m x 3m x 1.2m)

- Njerwa: Zokwana 1650
- Simenti: Matumba 10 a 50kilogramu
- Mchenga: Ngolo zinayi
- Matabwa: 2 pisi

Zida

- Mpeni omangira: 1 Umodzi
- Levulo: 1 Imodzi
- Shovelu: 1 Imodzi
- Wilibala: 1 Imodzi



Kuwerengera ndalama ndi zinthu zofunika kuti mpanda umangidwe

F1: Mpanda wa Tsekera

(Mmwezi wa September 2014)

No.	Kufotokoza	Chimodzi	Kuchuluka Kwake	Mtengo wa chimodzi (MK)	Zonse pamodzi (MK)	Ndemanga
1	Tsekera	Mtolo	25	300	7,500	
2	Khonje	Mtolo	30	30	900	
3	Linya	Pisi	100	50	5,000	
4	Nsungwi	Pisi	10	80	800	
4	Mitengo	Pisi	10	50	500	
5	Aganyu	Masiku	3	1,900	5,700	
					20,400	
Ndalama zonse						
Ndalama zonse zoyelekeza					21,000	

F2: Mpanda wa Mataabwa

(Mmwezi wa September 2014)

No.	Kufotokoza	Chimodzi	Kuchuluk a Kwake	Mtengo wa chimodzi (MK)	Zonse pamodzi (MK)	Ndemanga
1	Matabwa 2*4"	Pisi	10	1,550	15,500	
2	Matabwa 2*2"	Pisi	5	1,250	6,250	
3	Misomali 5"	Kilogalamu	1	800	800	
4	Misomali 6"	kilogalamu	1	800	800	
4	Solignamu	Lita	5	500	2,500	
5	Aganyu	Masiku	5	1,900	9,500	
					35,350	
Ndalama zonse						
Ndalama zonse zoyelekeza					36,000	

F3: Mpanda wa Nsungwi

(Mmwezi wa September 2014)

No.	Kufotokozza	Chimodzi	Kuchuluka Kwake	Mtengo wa chimodzi (MK)	Zonse pamodzi (MK)	Ndemanga
1	Nsungwi	Pisi	40	50	2,000	
2	Khonje	Mtolo	20	30	600	
3	Linya	Pisi	15	50	750	
4	Mitengo	Pisi	10	500	500	
5	Aganyu	Masiku	4	1,900	7,600	
					12,850	
Ndalama zonse						
Ndalama zonse zoyelekeza					13,000	

F4: Mpanda wa Zomera(Wa Maluwa)

(Mmwezi wa September 2014)

No.	Kufotokoza	Chimodzi	Kuchuluka Kwake	Mtengo wa chimodzi (MK)	Zonse pamodzi (MK)	Ndemanga
1	Zomera	Pisi	84	200	16,800	
2	Aganyu	Masiku	5	1,900	9,500	
3	Manyowa kopositi	Kilogalamu	200	3,000	3,000	1set=MK3,000
4	Feteleza	Kilogalamu	25	4,500	4,500	1set 25=Mk4,500
5	Mpanda wa matabwa	Mpanda	1	36,000	36,000	Kuchokera ku F2
Ndalama zonse					69,800	
Ndalama zonse zoyelekeza					70,000	

F5: Mpanda wa Njerwa

(Mmwezi wa September 2014)

No.	Kufotokoza	Chimodzi	Kuchuluka Kwake	Mtengo wa chimodzi (MK)	Zonse pamodzi (MK)	Ndemanga
1	Njerwa	Pisi	1,650	4	6,600	
2	Mchenga	Matani	2	800	1,600	1 tonne = 1000kg
3	Simenti	Matumba	6	6,500	39,000	
4	Matabwa	Pisi	2	3,500	7,000	
5	Omanga	Masiku	4	3,500	14,000	
6	Aganyu	Masiku	4	1,000	4,000	
Ndalama zonse					72,200	
Ndalama zonse zoyelekeza					73,000	



F6: Mpanda wa Njerwa koma wa pulasitala

(Mmwezi wa September 2014)

No.	Kufotokoza	Chimodzi	Kuchuluka Kwake	Mtengo wa chimodzi (MK)	Zonse pamodzi (MK)	Ndemanga
1	Njerwa	Pisi	1,650	4	6,600	
2	Mchenga	Matani	1	2,500	2,500	For plaster
3	Simenti	Matumba	10	6,500	65,000	
4	Pulasitiki	Pisi	100	20	2,000	
5	Matabwa	Pisi	2	1,250	2,500	
6	Misomali	Kilogalamu	0.5	800	400	
7	Hinjesi	Peya	1	800	800	
8	Aganyu	Masiku	5	1,900	9,500	
Ndalama zonse					89,300	
Ndalama zonse zoyelekeza					90,000	

Njira zimene mungasate pomanga mipanda

F1: Mpanda wa Tsekera

No	Zoyenera kuchita	Zipangizo zofunika	Zida	Chithunzi
1	Kumbani maenje mozungulira mjigo ndi kumanga mpanda wa mitengo poyamba ngati zengo	<ul style="list-style-type: none"> ➤ Mitengo ➤ Linya, Nkhonje 	<ul style="list-style-type: none"> ➤ Chikwanje 	
2	Mangani mpanda ndi tsekera	<ul style="list-style-type: none"> ➤ Tsekera ➤ Linya/Khonje ➤ Nsungwi ➤ Mitengo 	<ul style="list-style-type: none"> ➤ Khasu 	

F2: Mpanda wa Matabwa (Mitengo)

No	Zoyenera kuchita	Zipangizo zofunika	Zida	Chithunzi
1	Kumbani maenje mozungulira mjigo ndi kumanga mpanda wa matabwa (Mitengo).	<ul style="list-style-type: none"> ➤ Mitengo ➤ Linya 	<ul style="list-style-type: none"> ➤ Chikwanje 	

F3: Mpanda wa Nsungwi

No	Zoyenera kuchita	Zipangizo zofunika	Zida	Chithunzi
1	Kumbani maenje kuzungulira mjigo	<ul style="list-style-type: none"> ➤ Mitengo ➤ Linya 	<ul style="list-style-type: none"> ➤ Chikwanje 	
2	Mangani mpoanda wa nsungwi	<ul style="list-style-type: none"> ➤ Nsungwi ➤ Linya 	<ul style="list-style-type: none"> ➤ Chikwanje 	

F4: Mpanda wa zomera (Wa Maluwa)

No	Zoyenera kuchita	Zipangizo zofunika	Zida	Chithunzi
1	Kumbani maenje ozungulira mjigo ndi kumanga mpanda wa mitengo poyamba ngati zengo	<ul style="list-style-type: none"> ➤ Zomera ➤ Linya 	<ul style="list-style-type: none"> ➤ Makasu 	
2	Kumbani maenje ndi kudzala maluwa	<ul style="list-style-type: none"> ➤ Zomera ➤ Linya 	<ul style="list-style-type: none"> ➤ Makasu 	

F5: Mpanda wa Njerwa

No	Zoyenera kuchita	Zipangizo zofunika	Zida	Chithunzi
1	Kumbani maziko momwe muzadutse chipupa cha mpanda m'mbali mwa mjigo	<ul style="list-style-type: none"> ➤ Mitengo ➤ Linya 	<ul style="list-style-type: none"> ➤ Makasu ➤ Shovelu 	
2	Mangani mpanda wa njerwa	<ul style="list-style-type: none"> ➤ Njerwa ➤ Simenti ➤ Mchenga 	<ul style="list-style-type: none"> ➤ Shovelu ➤ Makasu 	

F6: Mpanda wa njerwa komanso wa pulasitala

No	Zoyenera kuchita	Zipangizo zofunika	Zida	Chithunzi
1	Kumbani maziko momwe muzadutse chipupa cha mpanda mbali ya mjigo	<ul style="list-style-type: none"> ➤ Mitengo ➤ Linya 	<ul style="list-style-type: none"> ➤ Makasu ➤ Shovelu 	
2	Mangani mpanda wa njerwa	<ul style="list-style-type: none"> ➤ Njerwa ➤ Simenti ➤ Mchenga 	<ul style="list-style-type: none"> ➤ Shovelu ➤ Makasu 	

No	Zoyenera kuchita	Zipangizo zofunika	Zida	Chithunzi
3	Mangani mpanda wa njerwa	<ul style="list-style-type: none"> ➤ Njerwa ➤ Simenti ➤ Mchenga 	<ul style="list-style-type: none"> ➤ Shovelo ➤ Makasu 	

S1: Dzenje lokumba losawaka koma Lovindikira

Kuyelekeza mtengo: 11,000 MK (M'mwezi wa September 2014)

Ubwino	Kuyipa kwake
<ul style="list-style-type: none"> • Ndi lotsika mtengo • Silimavuta kukumba (Limafuna anthu kukumba basi) 	<ul style="list-style-type: none"> • Limasakha dothi (Lingakumbidwe komwe dothi lake ndilolimba) • Mitengo simalimba itha kudyedwa ndi chiswe
Zipangizo [Chitsanzo] (L x B x H = 1m x 1m x 1m)	Zida
<ul style="list-style-type: none"> • Mitengo: Yokwana 8 	<ul style="list-style-type: none"> • Khasu: Limodzi • Chikwanje: Chimodzi • Shovelo: Imodzi

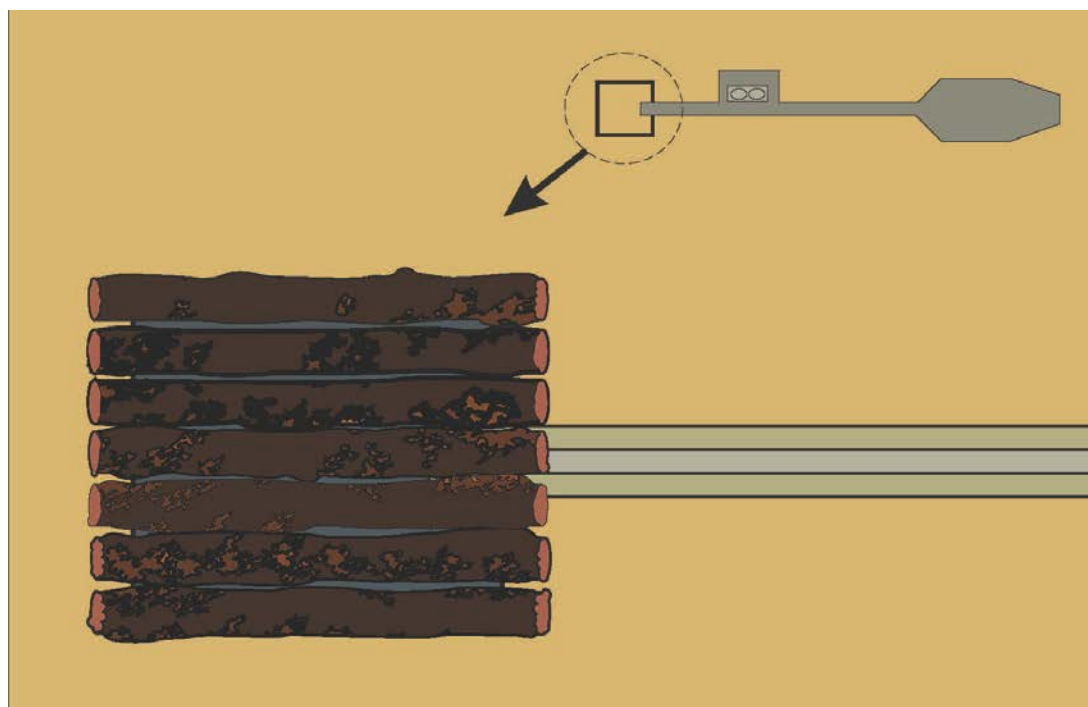
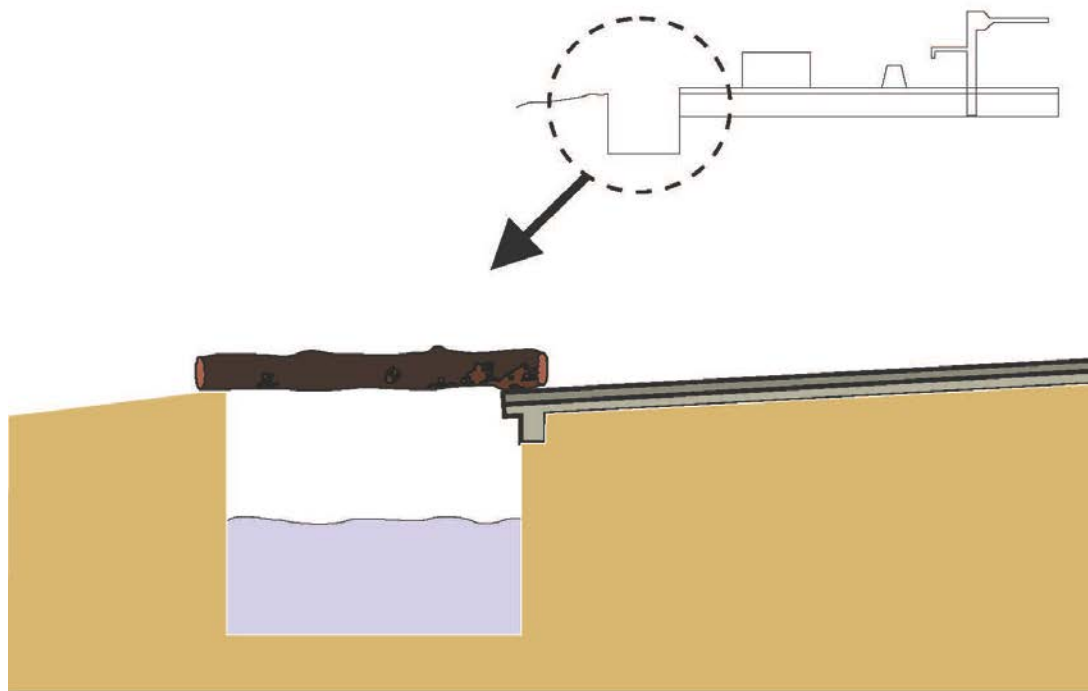

S2: Dzenje lokumba koma lowaka lili ndi chovindikira cha mitengo

Kuyelekeza mtengo: 15,000 MK (M'mwezi wa September 2014)

Ubwino	Kuyipa kwake
<ul style="list-style-type: none"> • Ndilolimba kusiyana ndi losawaka 	<ul style="list-style-type: none"> • Mitengo simakhalitsa komanso itha kudyedwa ndi chiswe • Simungakumbe dzenje lalitali kutengera dothi
Zipangizo [Chitsanzo] (L x B x H = 1m x 1m x 1m)	Zida
<ul style="list-style-type: none"> • Njerwa: Zokwana 100 • Mitengo: Yokwana 10 • Simenti: Theka la Thumba 	<ul style="list-style-type: none"> • Khasu: Limodzi • Chikwanje: Chimodzi • Shovelu: Imodzi

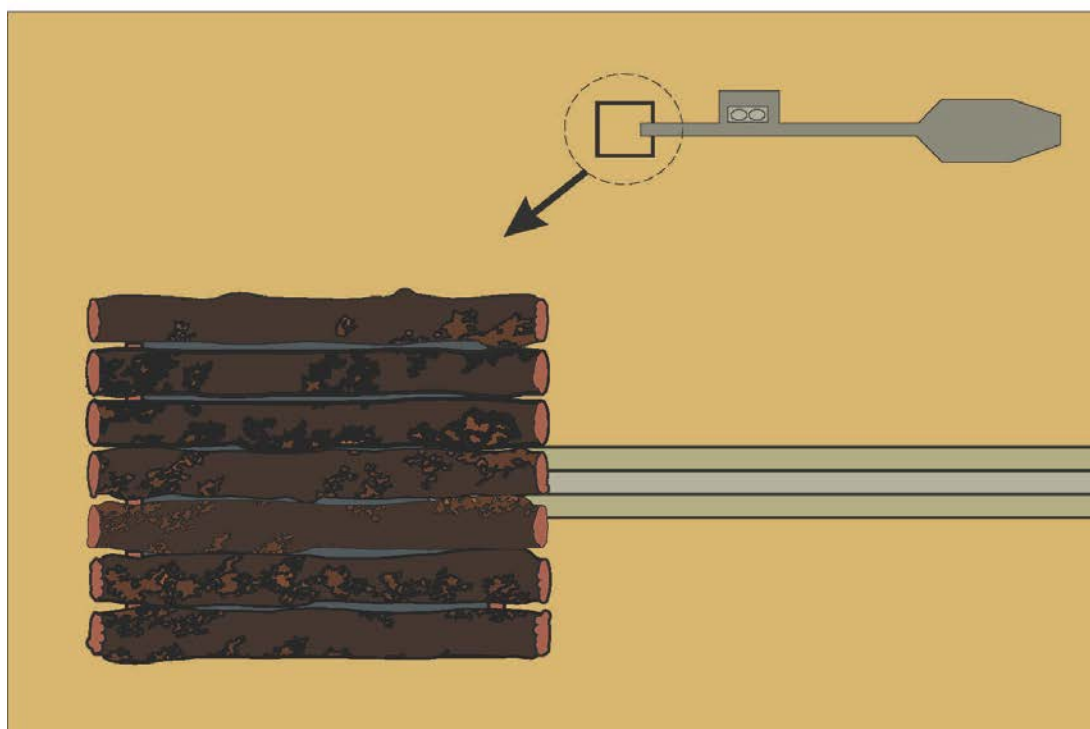
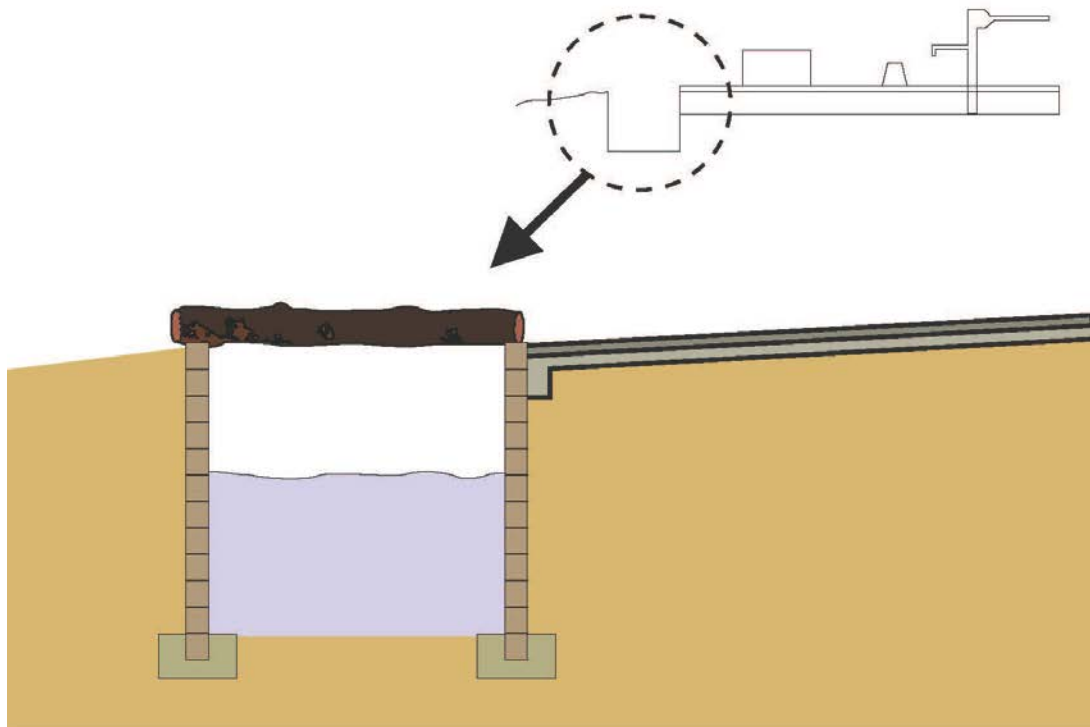

S3: Dzenje lokumba koma lili ndi miyala (Recommendable type)

Kuyelekeza mtengo: 10,000 MK (M'mwezi wa September 2014)

Ubwino	Kuyipa kwake
<ul style="list-style-type: none"> • Mutha kukumba mulimonse kaya mwa folokona kapena mozungulira • Silimavuta kumanga (Limafuna anthu kukumba basi) • Mtundu uwu umapezekapezeka 	<ul style="list-style-type: none"> • Limafuna kukonza pafupi pafupi
Zipangizo [Chitsanzo] (L x B x H = 1m x 1m x 1m)	Zida
<ul style="list-style-type: none"> • Miyala: Mawilibala Anayi 	<ul style="list-style-type: none"> • Khasu: Limodzi • Shovel: Imodzi • Wilibala: Imodzi

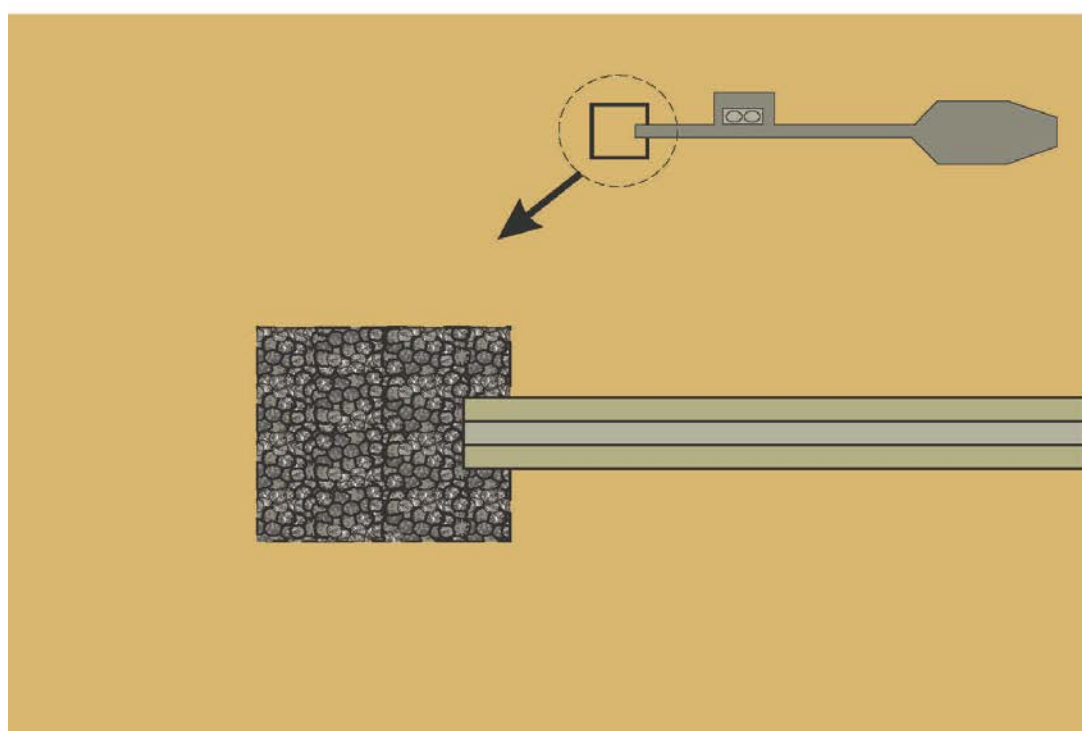
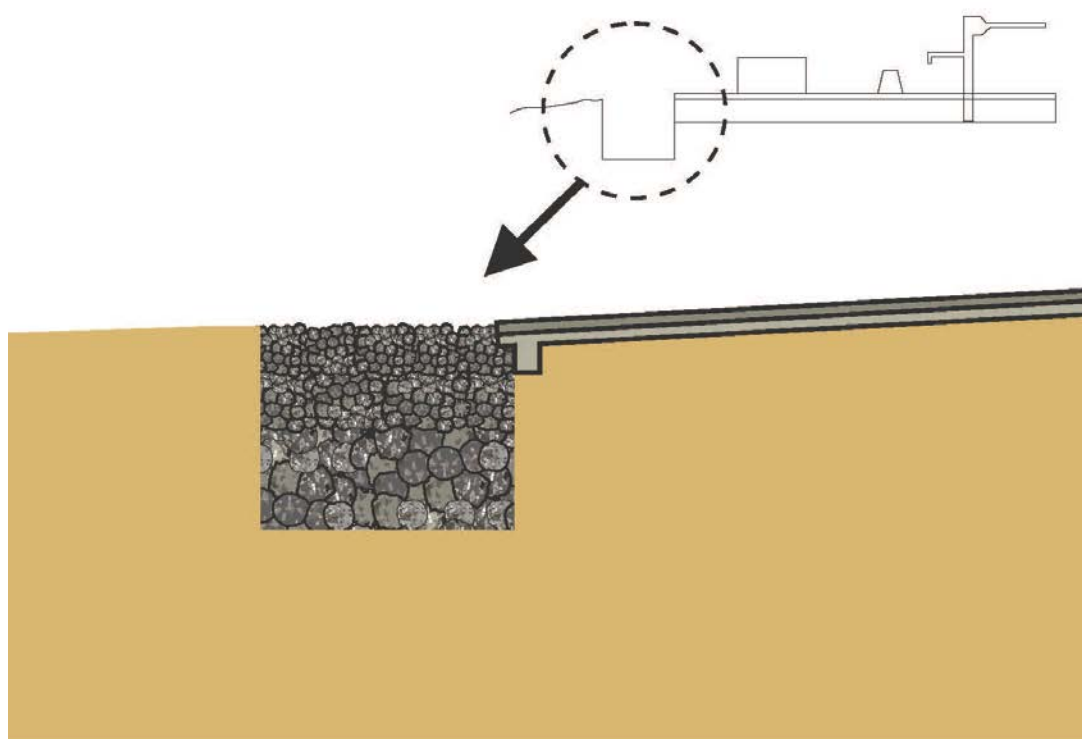

S4: Dzenje lokumba lowaka bwino lili ndi miyala (Recommendable type)

Kuyelekeza mtengo: 22,000 MK (M'mwezi wa September 2014)

Ubwino	Kuyipa Kwake
<ul style="list-style-type: none"> • Mutha kukumba mulimonse kaya mwa folokona kapena mozungulira • Ndilolimba • Mtundu uwu umapezekapezeka 	<ul style="list-style-type: none"> • Limafuna kukonza pafupi pafupi • Dzenje lake ndilokwera mtengo kuposa S1 ndi S3
Zipangizo [Chitsanzo] (L x B x H = 1m x 1m x 1m)	Zida
<ul style="list-style-type: none"> • Njerwa: Zokwana 100 • Simenti: Theka Thumba • Mchenja: Theka la Tani • Miyala: Theka la Tani 	<ul style="list-style-type: none"> • Mpeni womangira: Umodzi • Wilimbala: Imodzi • Shovel: Imodzi • Khasu: Limodzi

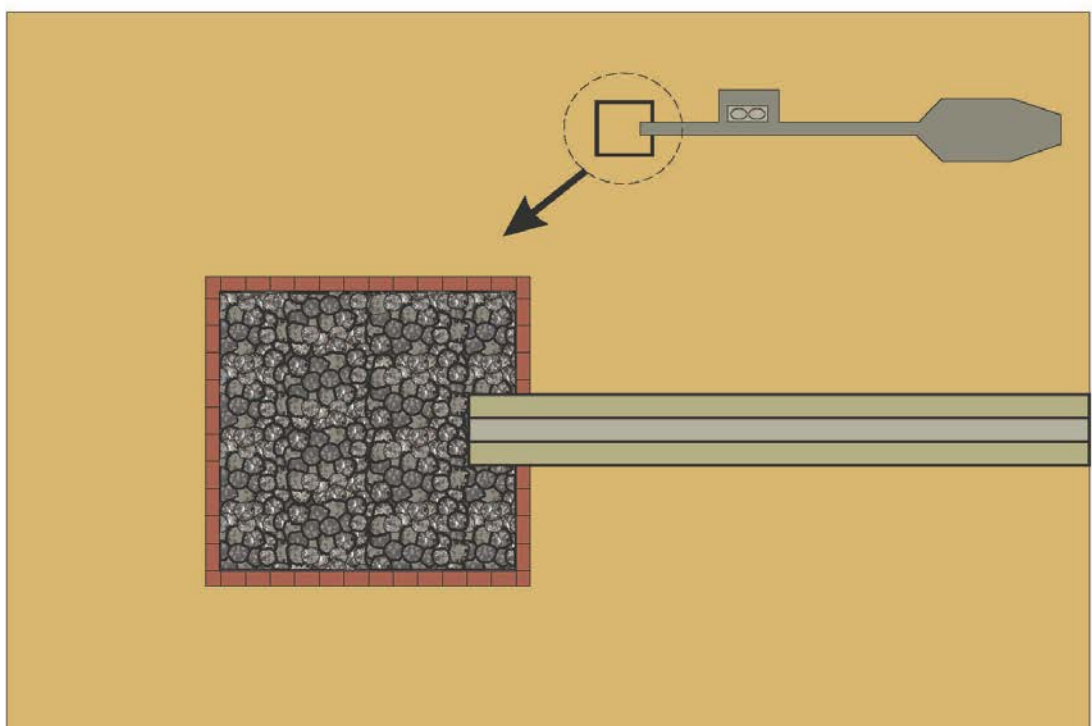
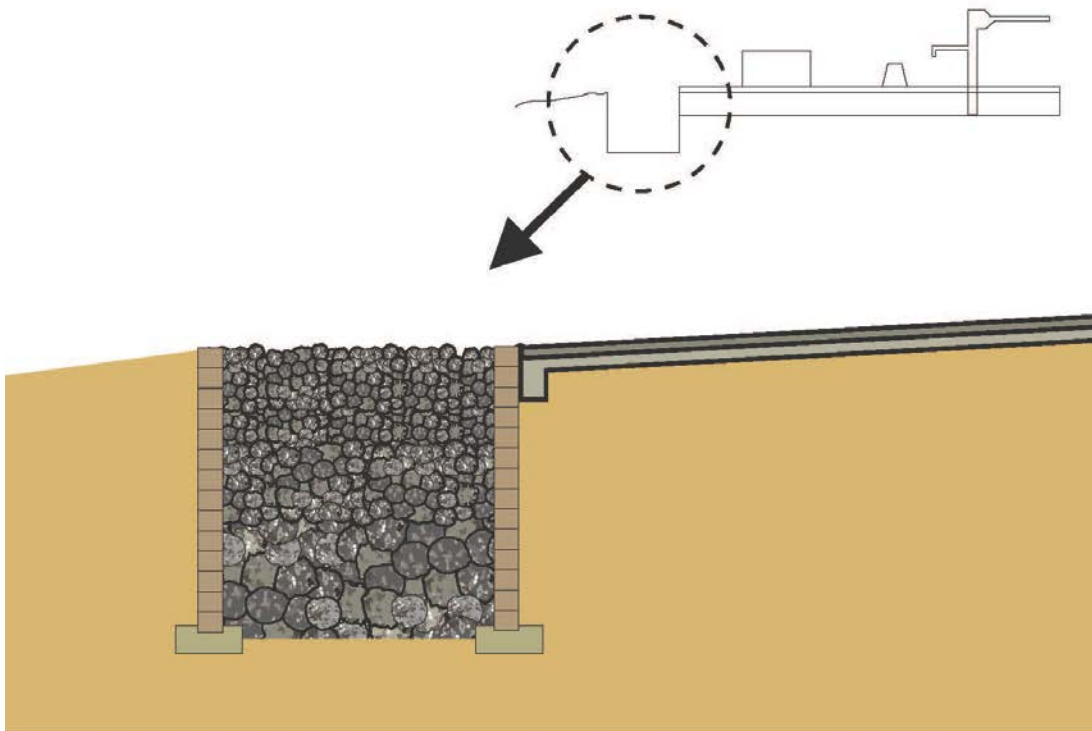

S5: Dzenje lowaka lokhala ndi chivindikoro cha konkiliti komanso ngalande zovindikira bwino (Recommendable type)

Kuyelekeza mtengo: 89,000 MK (M'mwezi wa September 2014)

Ubwino	Kuyipa kwake
<ul style="list-style-type: none"> ● Silimawononga chilengedwe ● Ndilolimba ● Limawoneka bwino kwambiri 	<ul style="list-style-type: none"> ● Limafuna ndalama zambiri ● Limafuna malo ambiri
Zipangizo [Chitsanzo] (L x B x H = 1m x 1m x 1m)	Zida
<ul style="list-style-type: none"> ● Njerwa: Zokwana 150 ● Simenti: Mabagi 6 a 50 kilogramu ● Mchenga: Ngolo ziwiri (1000kgs) ● Miyala: Ngolo Ziwiri (100kgs) ● Zitsulo: Chimodzi ndi paipi 	<ul style="list-style-type: none"> ● Mpeni womangira: Umodzi ● Wilimbala: Imodzi

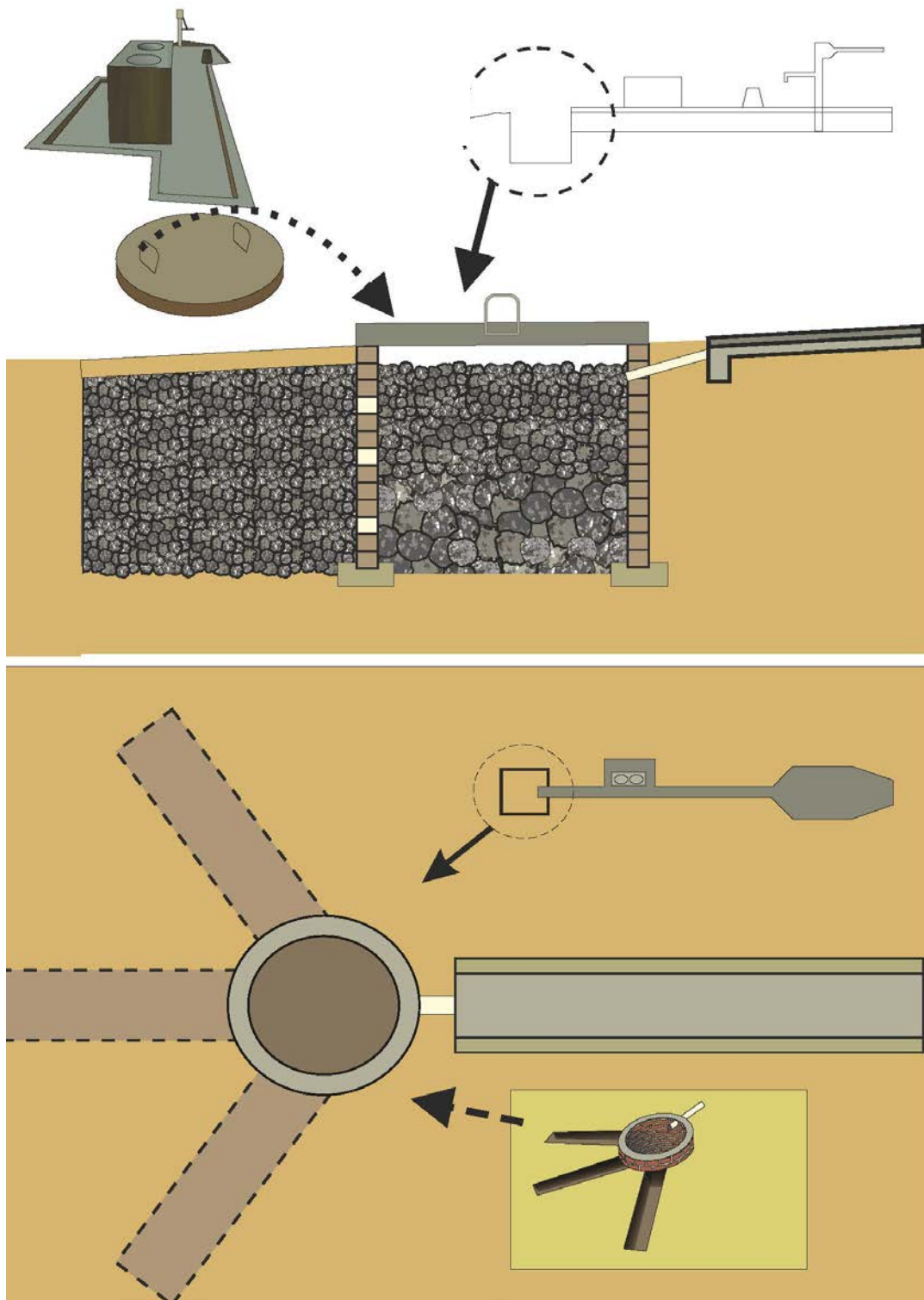

S6: Dimba

Kuyelekeza mtengo: 0 MK la Dimba koma 21,000 MK ya mpanda wa Tsekera(M'mwezi wa September 2014)

Ubwino	Kuyipa kwake
<ul style="list-style-type: none">● Silimawononga chilengedwe● Silimafuna ndalama● Silimavuta kumanga komanso kusamalira	<ul style="list-style-type: none">● Limafuna malo akulu.● Mbeu zimafuna mankhwala
Zipangizo [Chitsanzo] (L x B x H = 1m x 1m x 1m)	Zida
<ul style="list-style-type: none">● Feteleza: 10 kilogramu● Mbeu: 1 kilogramu	<ul style="list-style-type: none">● Khasu: Liomdzi



Kuwerengera ndalama ndi zinthu zofunika kuti maenje akumbidwe

S1: Dzenje lokumba losawaka koma lokhala ndi chivindikiro (Mmwezi wa September 2014)

No.	Kufotokoza	Chimodzi	Kuchuluka Kwake	Mtengo wa chimodzi (MK)	Zonse pamodzi (MK)	Ndemanga
1	Mitengo	Pisi	10	200	2,000	
2	Aganyu	Masiku	2	1900	3,800	
3	PVC 110mm pipe 6m mulitali	Pisi	1	4500	4,500	
Ndalama zonse					10,300	
Ndalama zonse zoyelekeza					11,000	

S2: Dzenje lokumba lowaka lili ndi chivindikiro (Mmwezi wa September 2014)

No.	Kufotokoza	Chimodzi	Kuchuluka Kwake	Mtengo wa chimodzi (MK)	Zonse pamodzi (MK)	Ndemanga
1	Njerwa	Pisi	100	4	400	
2	Simenti	Thumba	0.3	3,000	3,000	1Bag=50kg
3	Mchenga	Matani	0.5	2,000	1,000	1tonne=1000kg
4	Mitengo	pisi	10	200	2,000	
5	Paipi(PVC)110mm 6m mulitali	pisi	1	4,500	4,500	
6	Aganyu	Masiku	2	1,900	3,800	
Ndalama zonse					14,700	
Ndalama zonse zoyelekeza					15,000	

S3: Dzenje lokumba koma lili ndi miyala (Mmwezi wa September 2014)

No.	Kufotokoza	Chimodzi	Kuchuluka Kwake	Mtengo wa chimodzi (MK)	Zonse pamodzi (MK)	Ndemanga
1	Aganyu	Masiku	2	1,900	3,800	
2	Paipi(PVC) 110mm 6m mutali	mm	1	4,500	4,500	
3	Miyala	Mawilibala	0.5	2,000	1,000	
Ndalama zonse					9,300	
Ndalama zonse zoyelekeza					10,000	

S4: Dzenje lokumba lowaka lili ndi chivindikiro cha mitengo (Mmwezi wa September 2014)

No.	Kufotokoza	Chimodzi	Kuchuluka Kwake	Mtengo wa chimodzi (MK)	Zonse pamodzi (MK)	Ndemanga
1	Njerwa	Pisi	100	4	400	
2	Simenti	Matumba	1	6,500	6,500	1bag= 50kg
3	Mchenga	Matani	0.5	2,000	1,000	
4	Miyala	Matani	1	5,000	5,000	1 tonne=1000kgs
5	Paipi(PVC)110mm 6m mulitali	Pisi	1	4,500	4,500	
6	Aganyu	Masiku	2	1,900	3,800	
Ndalama zonse					21,200	
Ndalama zonse zoyelekeza					22,000	

S5: Dzenje lokumba lowaka lili ndi chivindikiro

(Mmwezi wa September 2014)

No.	Kufotokoza	Chimodzi	Kuchuluka Kwake	Mtengo wa chimodzi (MK)	Zonse pamodzi (MK)	Ndemanga
1	Njerwa	Pisi	150	4	600	
2	Simenti	Matumba	6	6,500	39,000	1bag= 50kg
3	Mchenga	Matumba	1	5,000	2,000	
4	Miyala	Matani	1	5,000	5,000	1 tonne=1000kgs
5	Paipi(PVC)110 6m mulitali	Pisi	1	4,500	4,500	
6	Chitsulo cha Y10	Pisi	1	2,850	2,850	
7	Aganyu	Masiku	4	1,900	7,600	
8	Ngalande yoyamba Miyala	Matani	1	5,000	5,000	
9	Pepala ngalande zonse zitatu	Mita	100	100	10,000	
10	Ngalande yachiwiri miyala	Matani	1	5,000	5,000	
11	Ngalande yachitatu Miyala	Matani	1	5,000	5,000	1 tonne= 1000kgs
12	Mayendedwe	Maulendo	4	500	2,000	1trip= 500kg

No.	Kufotokoza	Chimodzi	Kuchuluka Kwake	Mtengo wa chimodzi (MK)	Zonse pamodzi (MK)	Ndemanga
Ndalama zonse					88,550	
Ndalama zonse zoyelekeza					89,000	

S6: Dzenje la mtundu wokhala ndi Dimba

(Mmwezi wa September 2014)



No.	Kufotokonza	Chimodzi	Kuchuluka Kwake	Mtengo wa chimodzi (MK)	Zonse pamodzi (MK)	Ndemanga
1	Mpanda wa tsekera	1	1	21,200	21,200	F1
Ndalama zonse					21,200	
Ndalama zonse zoyelekeza					22,000	

Njira Zomangira maenje otaikiramo madzi

S1: Dzenje lokumba koma lovindikira

No	Zoyenera kuchita	Zipangizo zofunika	Zida	Chithunzi
1	Kumbani dzenje mwa folokona	➤	<ul style="list-style-type: none"> ➤ Makasu ➤ Shovelu 	
2	Vindikirani ndi mitengo mutadula bwino.	➤ Mitengo	<ul style="list-style-type: none"> ➤ Chochekera ➤ Chikwanje 	

S2: Dzenje lokumba koma lowaka lili ndi chivindikiro

No	Zoyenera kuchita	Zipangizo zofunika	Zida	Chithunzi
1	Kumbani dzenje ndi kuwaka ndi njerwa	<ul style="list-style-type: none"> ➤ Njerwa ➤ Simenti ➤ Mchenga 	<ul style="list-style-type: none"> ➤ Makasu ➤ Shovelu 	
2	Vindikirani ndi mitengo	➤ Mitengo	<ul style="list-style-type: none"> ➤ Chochekera ➤ Chikwanje 	





S3: Dzenje lokumba koma lili ndi miyala



No	Zoyenera kuchita	Zipangizo zofunika	Zida	Chithunzi
1	Kumbani dzenje ndi kuyikamo miyala kutalika kumatengera mtundu wa dothi	➤ Miyala	<ul style="list-style-type: none"> ➤ Khasu ➤ Shovelu 	

S4: Dzenje lokumba lowaka bwino lili ndi miyala

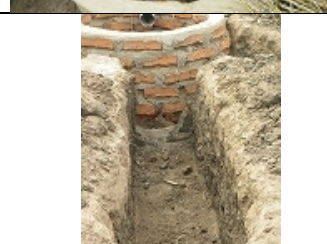
No	Zoyenera kuchita	Zipangizo zofunika	Zida	Chithunzi
1	Kumbani dzenje ndi kuwaka mbali ndi njerwa	<ul style="list-style-type: none"> ➤ Miyala ➤ Simenti ➤ Mchenga ➤ Njerwa 	<ul style="list-style-type: none"> ➤ Makasu ➤ Shovelu 	

S5: Dzenje lowaka lokhala ndi chivindikiro cha konkiliti komanso ngalande zovindikira bwino

No	Zoyenera kuchita	Zipangizo zofunika	Zida	Chithunzi
1	Poyamba yesani momwe mudutse ngalande	<ul style="list-style-type: none"> ➤ Tepi 	<ul style="list-style-type: none"> ➤ Khasu ➤ Shovelu 	
2	Poyamba kumbani dzenje ndi kuwaka ndi njerwa	<ul style="list-style-type: none"> ➤ Miyala ➤ Simenti ➤ Mchenga ➤ Njerwa ➤ Waya ➤ Pepala 	<ul style="list-style-type: none"> ➤ Makasu ➤ Shovelu 	 
3	Kumbani ngalande yoyamba	<ul style="list-style-type: none"> ➤ Miyala ➤ Pepala 	<ul style="list-style-type: none"> ➤ Makasu ➤ Shovelu 	
4	Kumbani ngalande yachiwiri	<ul style="list-style-type: none"> ➤ Miyala ➤ Pepala 	<ul style="list-style-type: none"> ➤ Makasu ➤ Shovelu 	
5	Kumbani ngalande yachitatu	<ul style="list-style-type: none"> ➤ Miyala ➤ Pepala 	<ul style="list-style-type: none"> ➤ Makasu ➤ Shovelu 	

No	Zoyenera kuchita	Zipangizo zofunika	Zida	Chithunzi
				
6	Mangani Chivindikiro cha simenti	<ul style="list-style-type: none"> ➤ Waya ➤ Simenti ➤ Miyala 	<ul style="list-style-type: none"> ➤ Khasu ➤ Shovelu 	 

S6: Dimba

No	Zoyenera kuchita	Zipangizo zofunika	Zida	Chithunzi
1	Pangani ma bedi ndi kudzala mbeu pogwiritsa ntchito madzi otaikira pa mjigo	<ul style="list-style-type: none"> ➤ Tsekera ➤ Mbeu ➤ Zitini 	<ul style="list-style-type: none"> ➤ Makasu 	 

Tool 12

Village Head's Consensus Form for the Promotion of Water Point Sanitation

Fomu ya Chitsimikizo cha mfumu cholimbikitsa ukhondo wapa mjigo.

Khalani mudzi wachitsanzo ndi wathanzi



Government of Malawi

Samalirani mjigo ndi malo ozungulira, nthawi zonse



Ine, _____ wa m'mudzi
 wa _____, ndikulonjeza kuti mudzi wathu
 udzakhala wachitsanzo ndi wathanzi posamalira mjigo ndi malo ozungulira.

 (Dzina la Mfumu)

 (Saini)

 (Tsiku)

Pa maso pa:

 (Dzina la wapampando wa WPC)

 (Saini)

 (Tsiku)

ndi

 (Dzina la mboni)

 (Saini)

 (Tsiku)

MJIGO:

MUDZI:

Tool 13

Promotion Song for Water Point Sanitation (We should not underrate)

Nyimbo yolimbikitsa ukhondo wa pa mjigo (Tisamanyozere)

SONG 2 TISAMANYOZERE

VERSE 1

Odi odi kumudziko ndabwera ndinkhani ndilandireni
Nkhani yanga ine siyapatali ndichisamaliro chapamjigo
Madzi apamjigo ndiaukhondo ndipo amatuluka ali-abwino zedi
Koma ngati sitisamalira pamjigo patha kulowa matenda
Mjigo wathu tiusamalire usayandikane ndi zonyasa zonse
Usakhale pafupi ndichimbudzi komanso dzala likhale kutali
Timange kampanda kuzungulira pamjigo pathu
Tisaiwalenso kukumba dzenje motaikira madziapamjigo
Dzenje lake lalitali bwino komanso tiikemo miyala
Pazikhali posesa bwino nthawi zonse tisalore umve

CHORUS

Lead Nkanakonda muli mudzi wachitsanzo
All Tisamanyozere
Lead Panchito yosamalira pamjigo
All Tisamanyozere
Lead Akabwera alendo azisilira
All Tisamanyozere
Lead Azikopeka ndikukapanganso choncho
All Tisamanyozere

VERSE 2

Akulu amati wakutsina khutu ndiye mnasi wako
Amanenanso momveka bwino ukundisokosa nkulinga utamva iwe
Ndiundo wanu azimayi kutenga mbali pantchitoyi
Poti ntchito yonse yaukhondo wapakhomo iimira inu
Ndimvereninsu azibambomusakhale chete chilimikani
Poti nchito yosamala mjigo popanda inu ndithu siingatheke

Ndikupemphaninsu mafumu mavolontiya ndi village band
Alimbikitseni anthu anu kusamalira mijigo yao
Pamjigo pakakhala paukhondo mudzi onse umalemekezeka
Anthu ochokera midzi yozungulira naonso amatenga chitsanzo

TRADITIONAL TUNE

Lead Sitindalore kukhala chitsanzo chaumve
Back Sitingalore kukhala chitsanzo chaumve
Lead Takonzeka kukhala chitsanzo chaukhondo
Back Takonzeka kukhala chitsanzo chaukhondo
Lead Takonzeka kukhala mudzi wa chitsanzo ife
Back Takonzeka kukhala mudzi wa chitsanzo ife
Lead Pantchito yosamala pamjigo pathu ife
Back Pantchito yosamala pamjigo pathu ife
Lead Akabwera alendo azisilira ife
Back Akabwera alendo azisilira ife
Lead Amfumu athu ali patsogolo
Back Amfumu athu ali patsogolo
Lead Azimayi ndi abambo tili pambuyoyo
Back Azimayi ndi abambo tili pambuyoyo

CHORUS

Lead Nkanakonda muli mudzi wachitsanzo
All Tisamanyozere
Lead Panchito yosamalira pamjigo
All Tisamanyozere
Lead Akabwera alendo azisilira
All Tisamanyozere
Lead Azikopeka ndikukapanganso choncho
All Tisamanyozere

Tool 14

O&M Schedule

Mndandanda wa mmene tiziyendetsera ndi kukonzamjigo wathu

Kuunika Mjigo pasabata iliyonse.

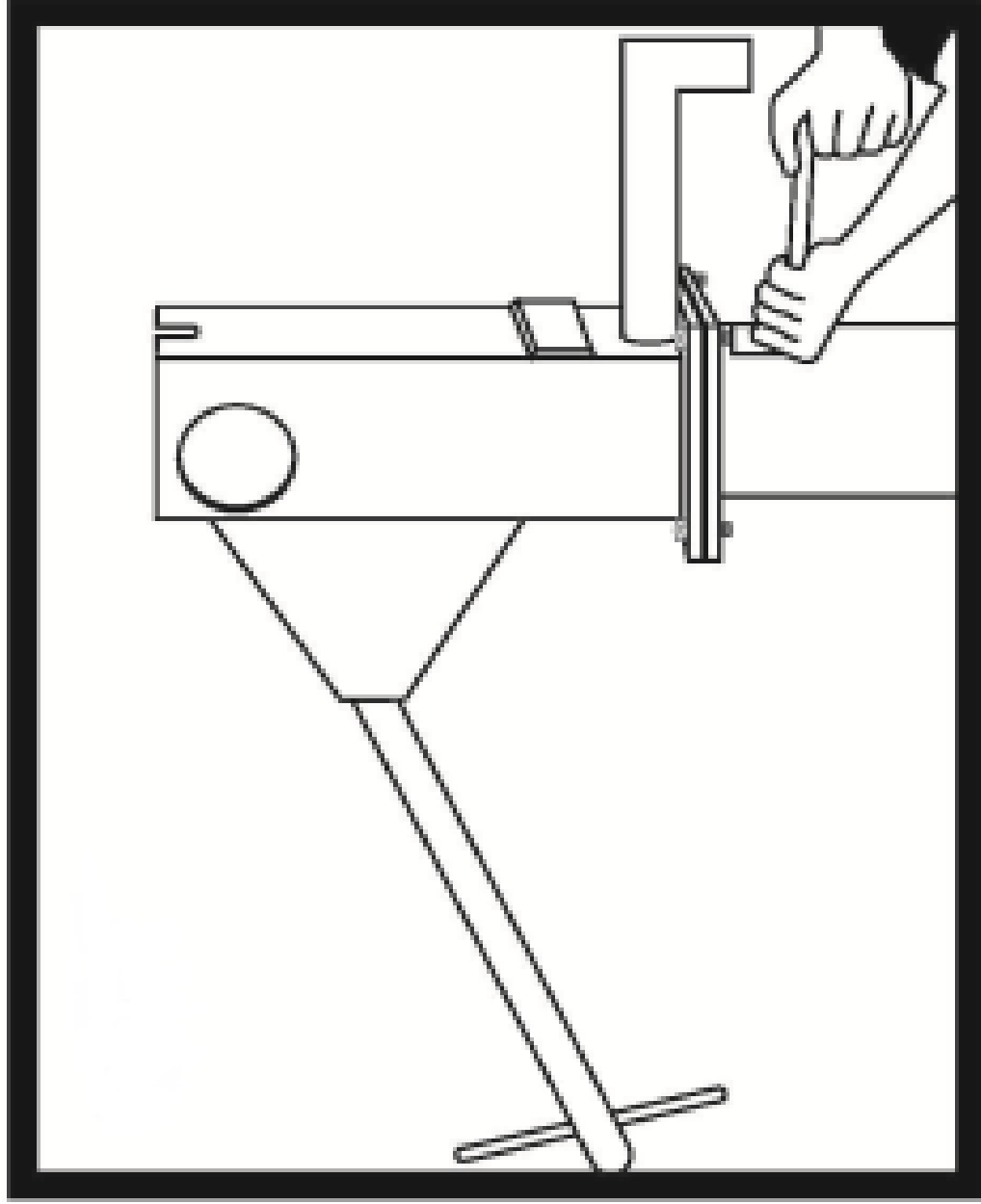

Onani ngati mabauti ndi manati ndi omangika.

1

Kuunika mjigo pa sabata iliyonse.

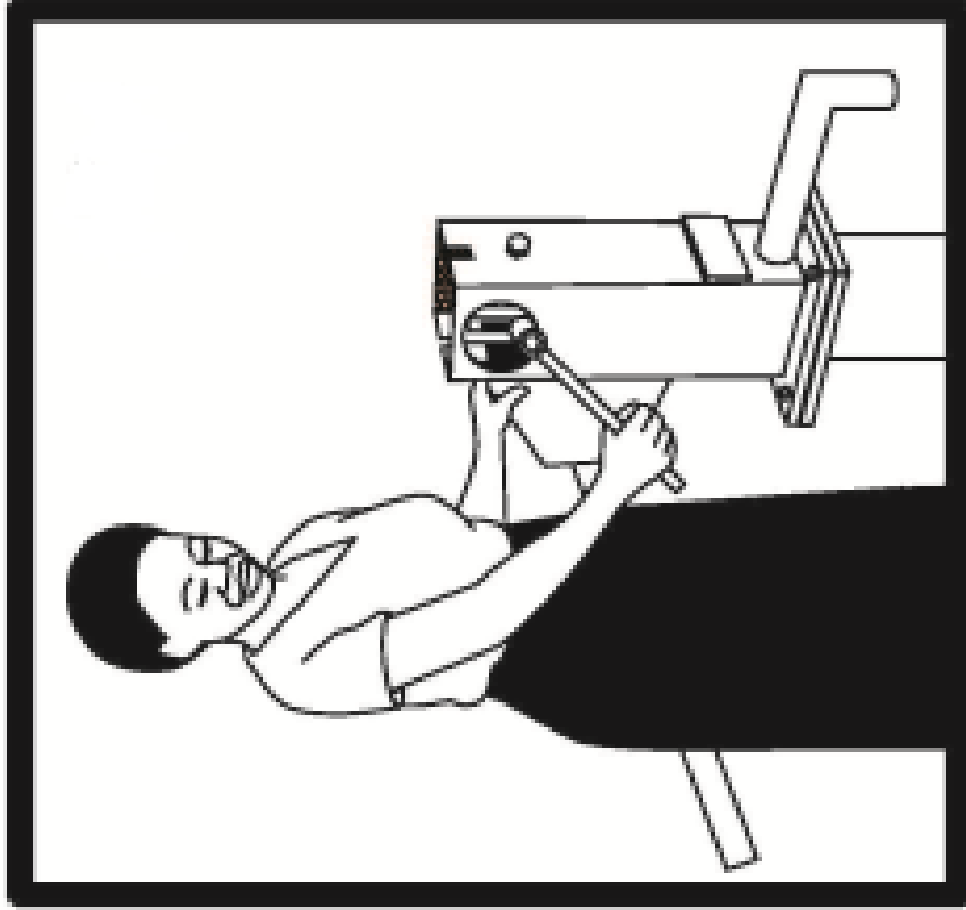
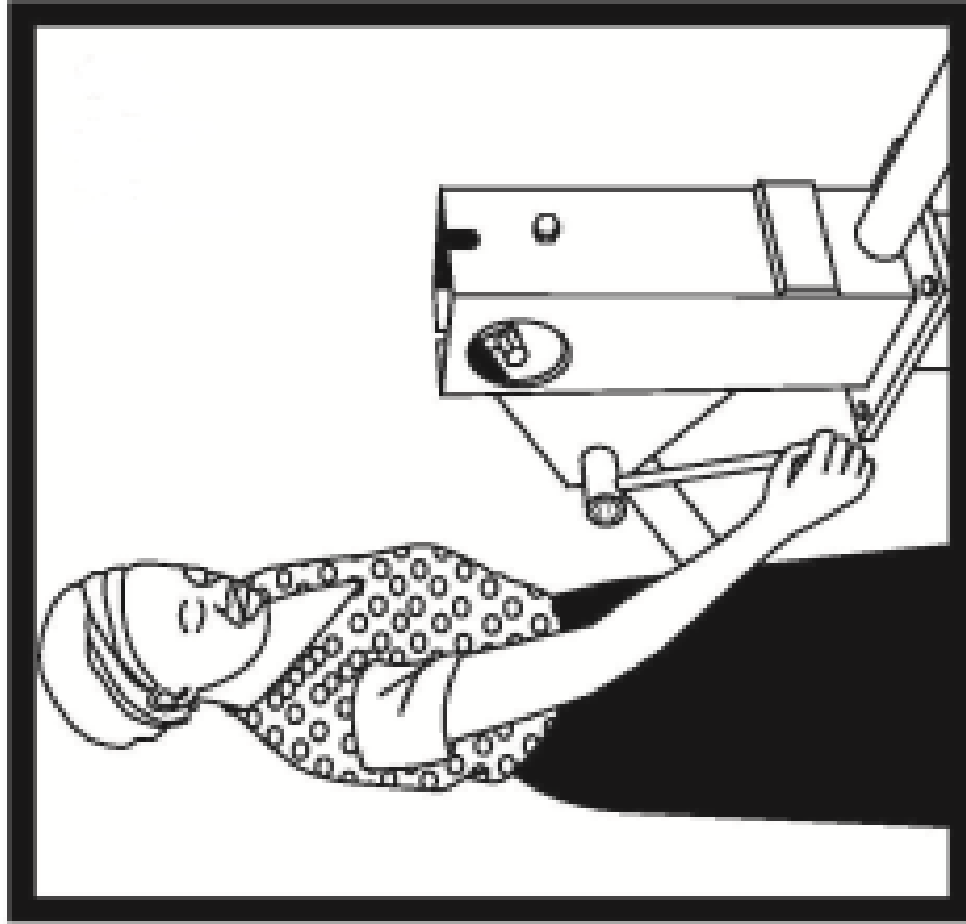

2

Onani ngati manati ndi mabauti fakalamu ndi hangá pin ndi omangika.

Kuunika mjigo pa mwezi uliwonse 2.

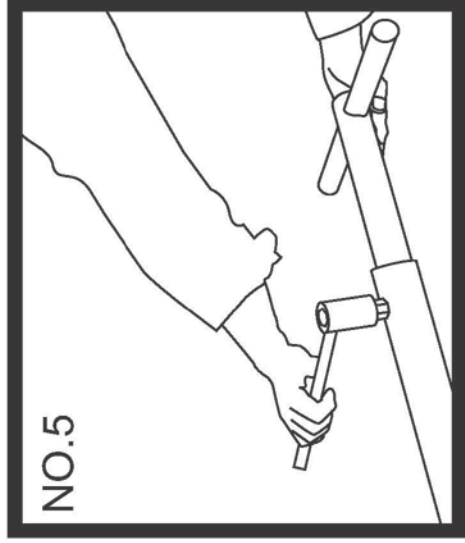
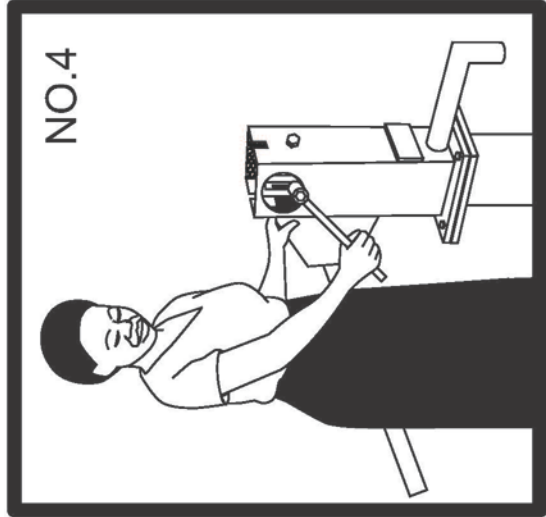
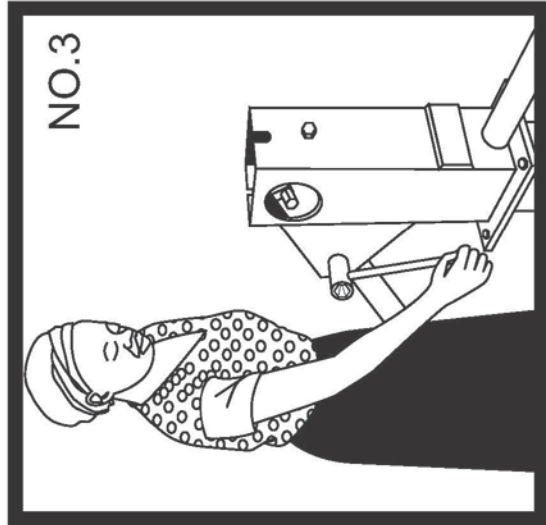
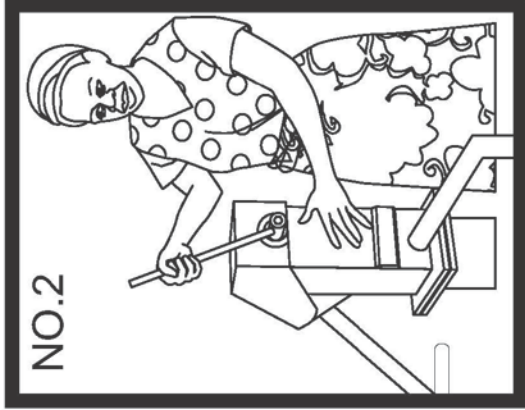
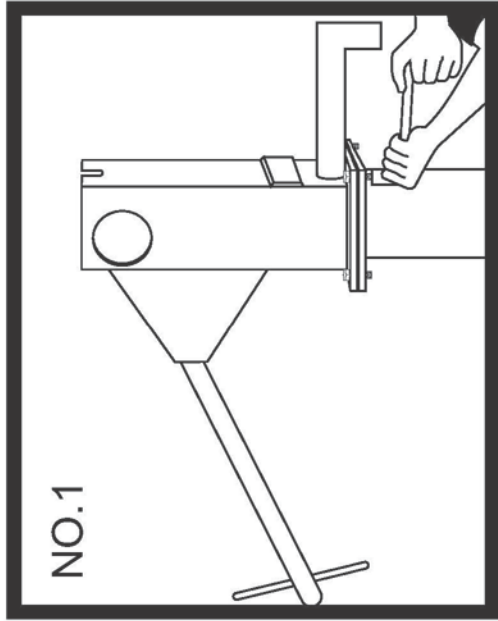

Kuunika mjigo pa mwezi uliwonse 2

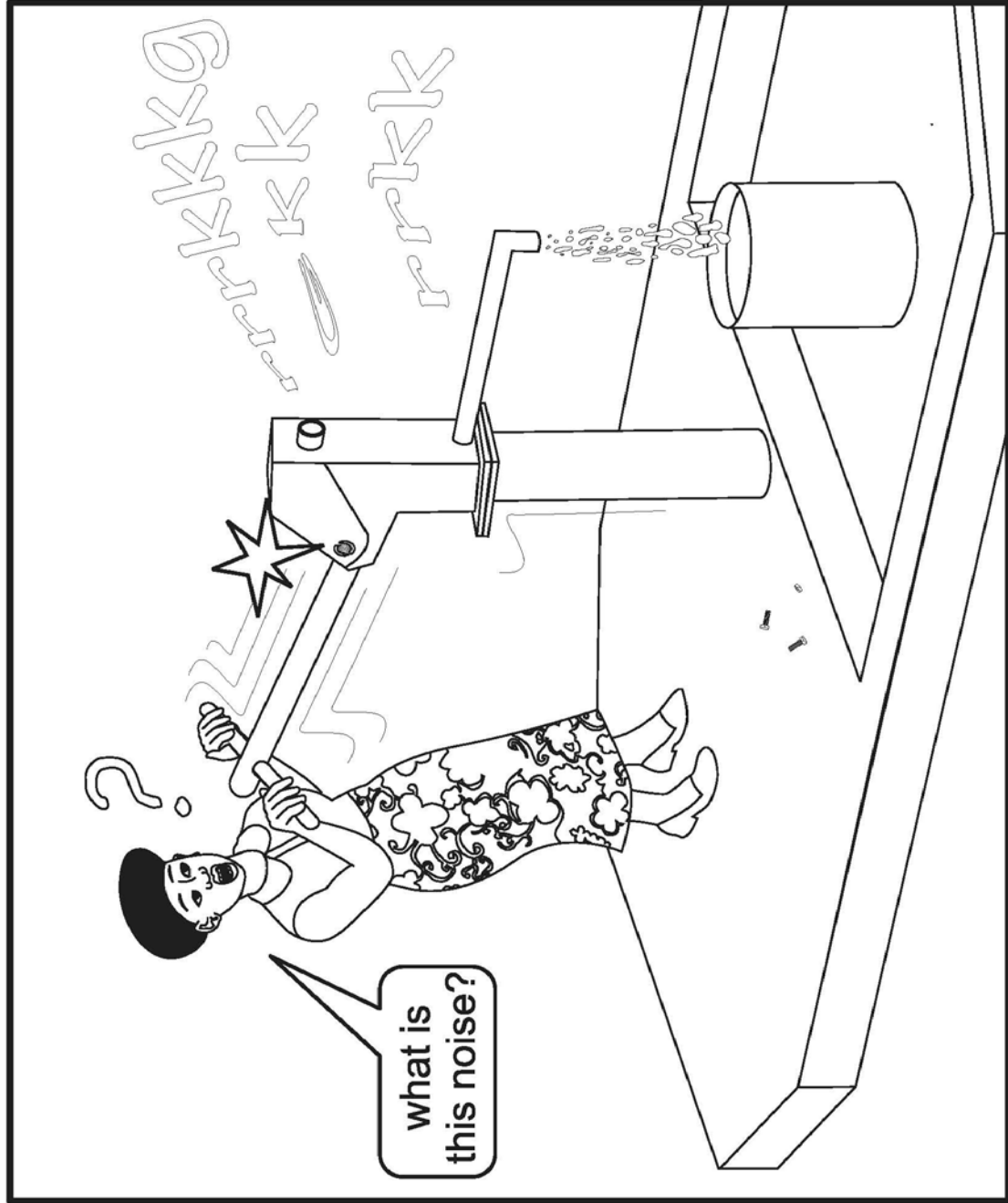

Kuunika Mjigo pa mwezi uliwonse iliyonse 3.

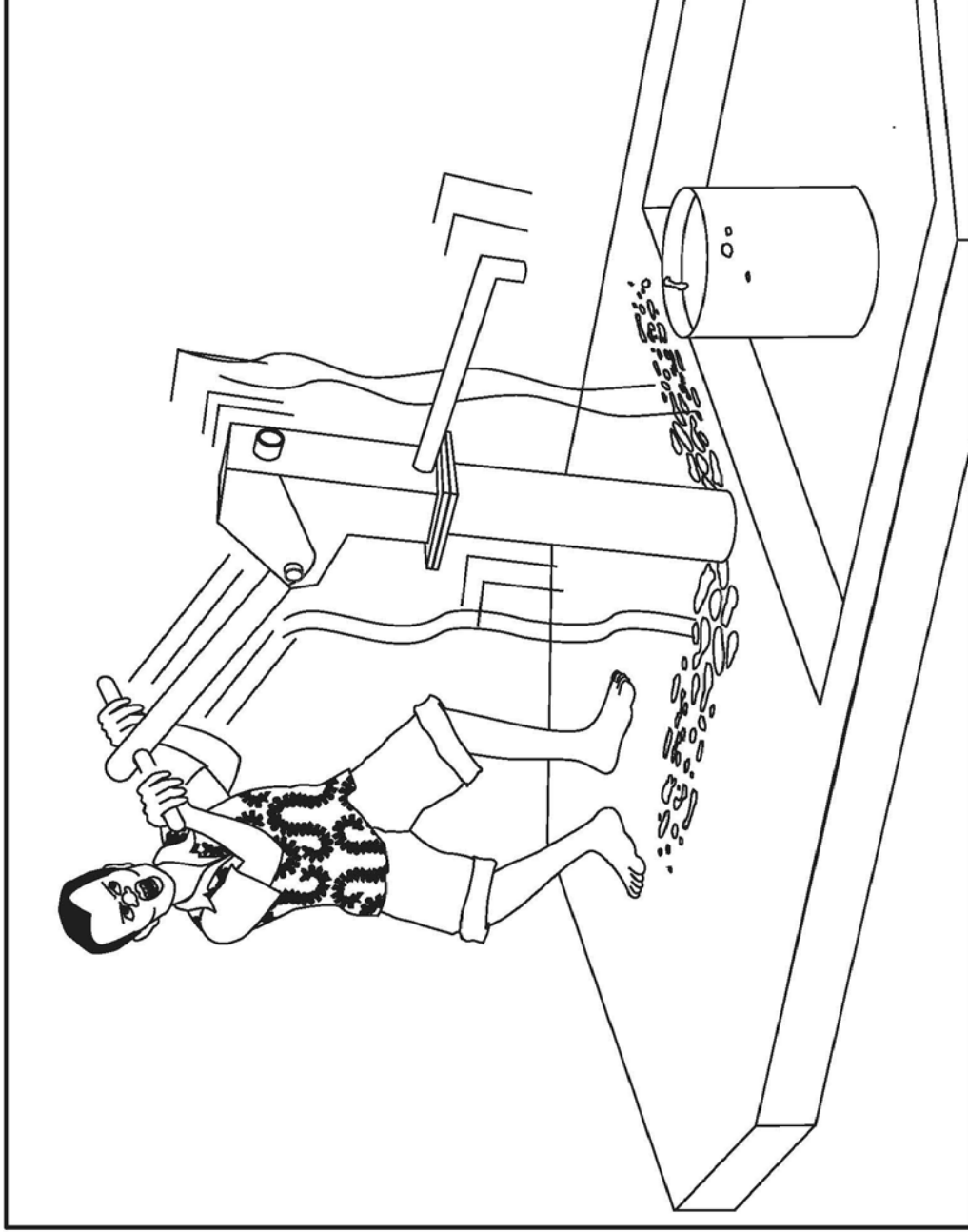

3

Onani ngati thunthu la mjigo silikugwadera pojiga . ndipo ngati thunthu ligwadera pojiga zimenezi zingapangitse madzi kuwonongeka. Konzani vutolo pomanganso konkiriti yatsopano.

Kuunika mjigo pa mwezi uliwonse.

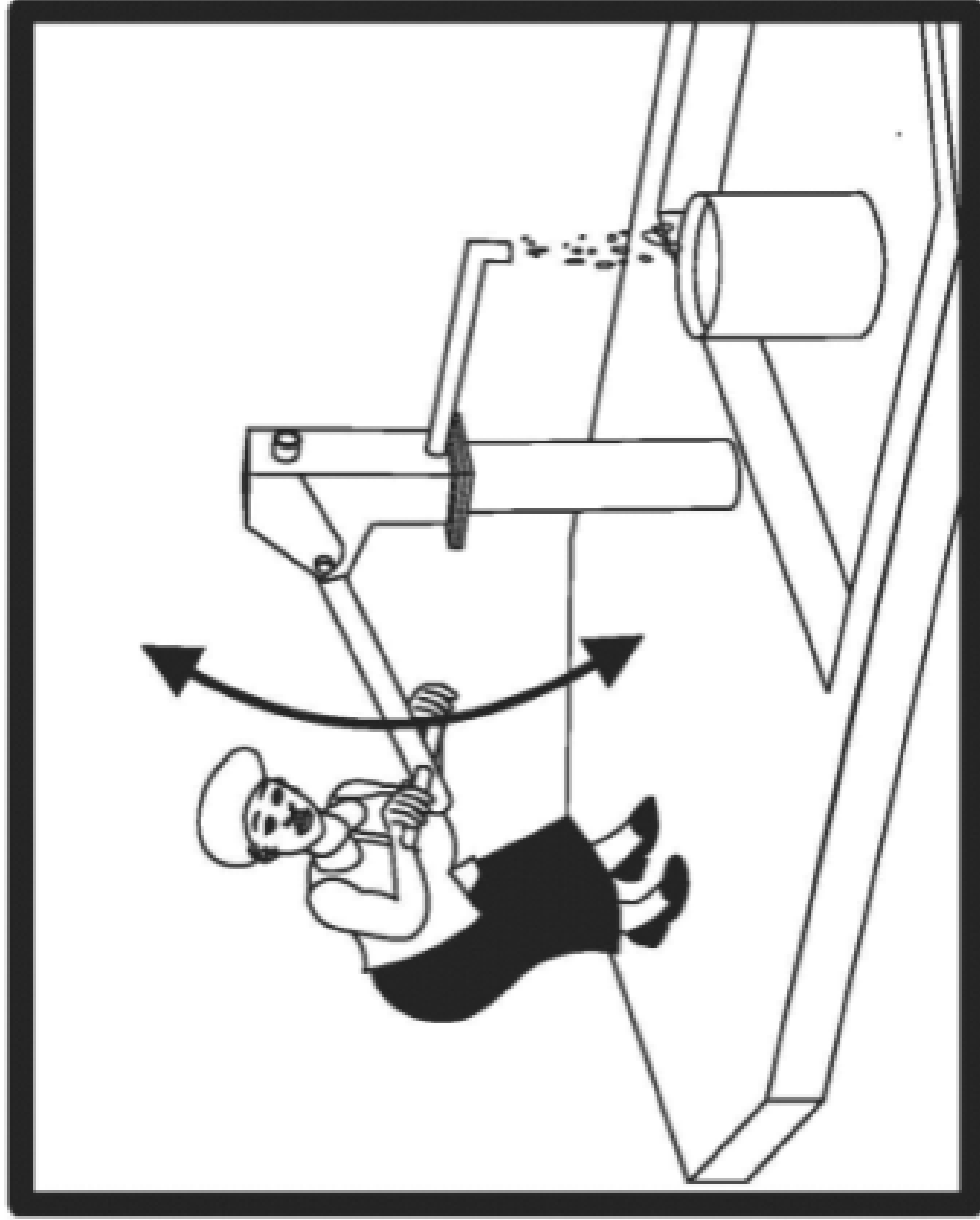

4&5

Yesani kuchucha kwa madzi ndi kuchuluka kwa madzi amene akutuluka. Funsani Amakaniki kapena alangizi az madzi machitidwe ake ngati zingakuvuteni.

Tool 15

Trouble Shooting Booklet (Afridev Handpump Version)

Buku lothandiza pokonza mavuto a pampu ya mjigo wa Afridev

Kufufuza Mavuto ndi Kukonza Mjigo wa Afridev Ukaonongeka

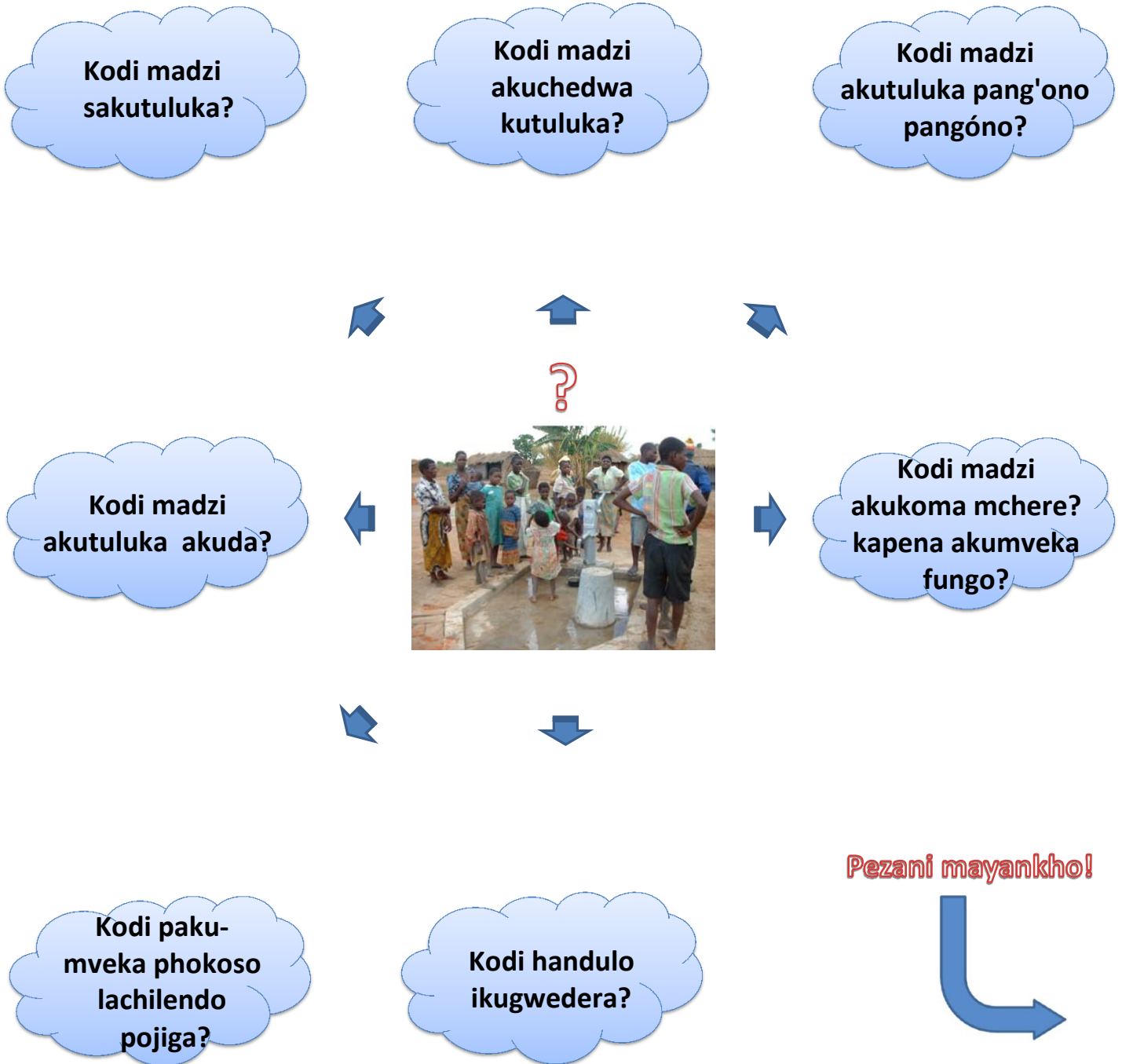

The Project for Enhancement of Operation and Maintenance for Rural Water Supply

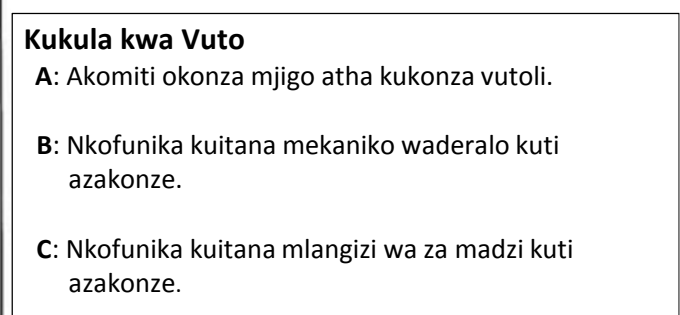
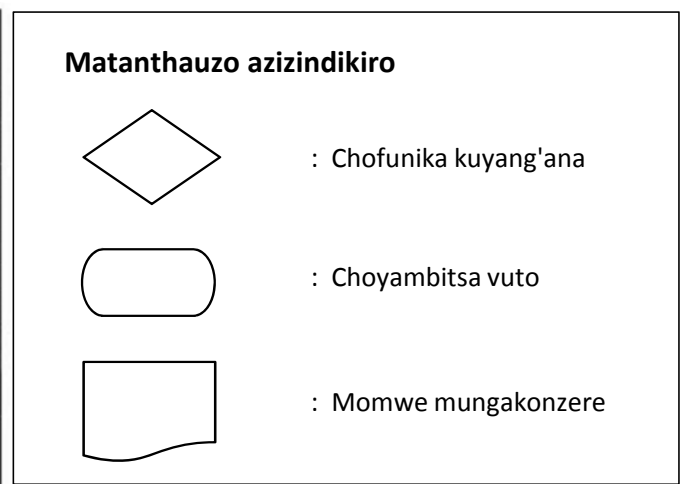
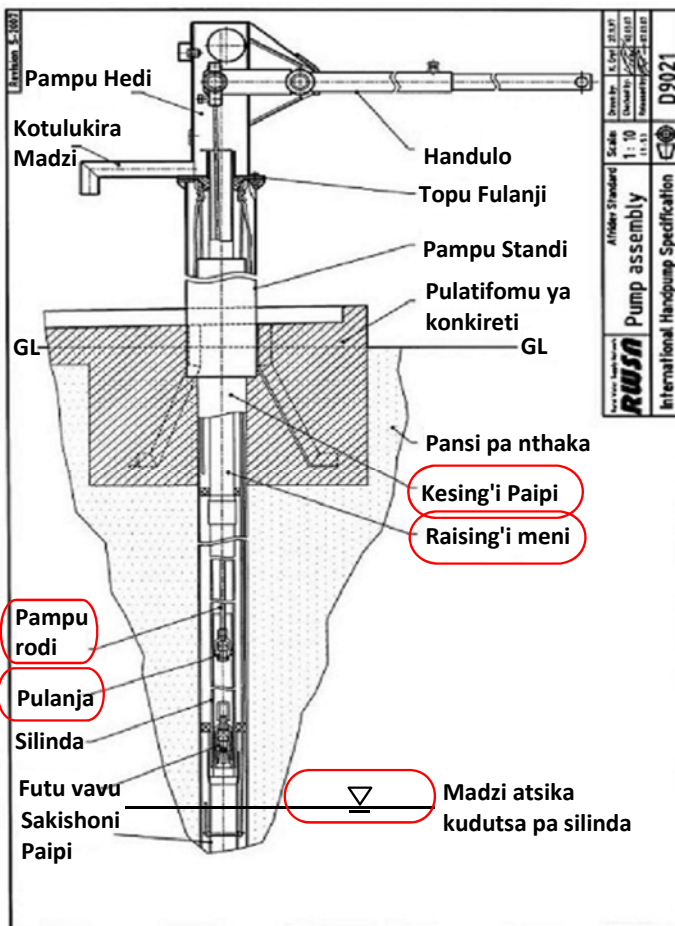
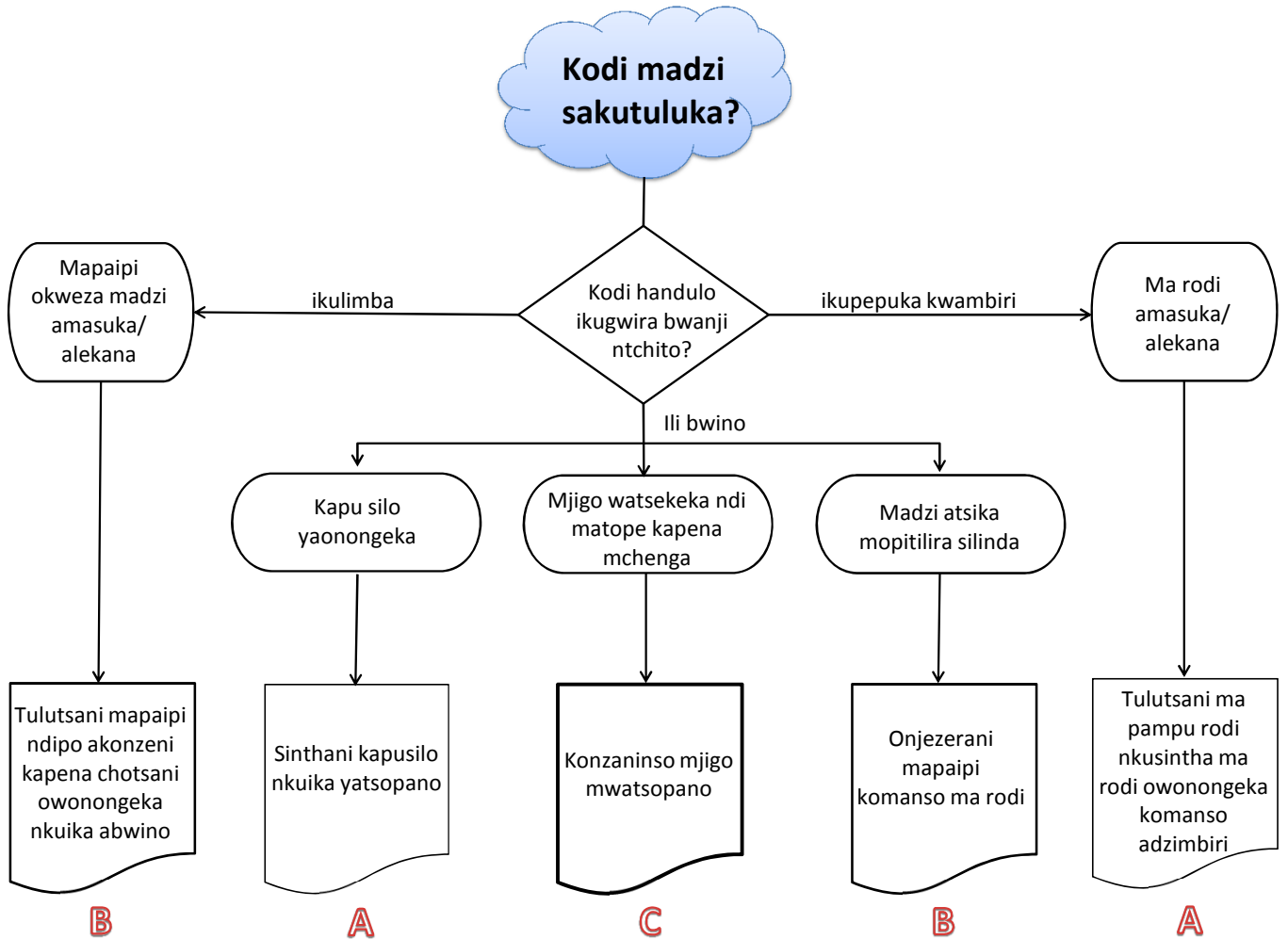

Dzina la Mudzi	
Dzina la Mfumu Yaikulu	
Dzina la Boma	

	Dzina	Nambala ya foni
Mekaniko wa mjigo		
Mlangizi wa zamadzi		
Mkulu wa zamadzi		

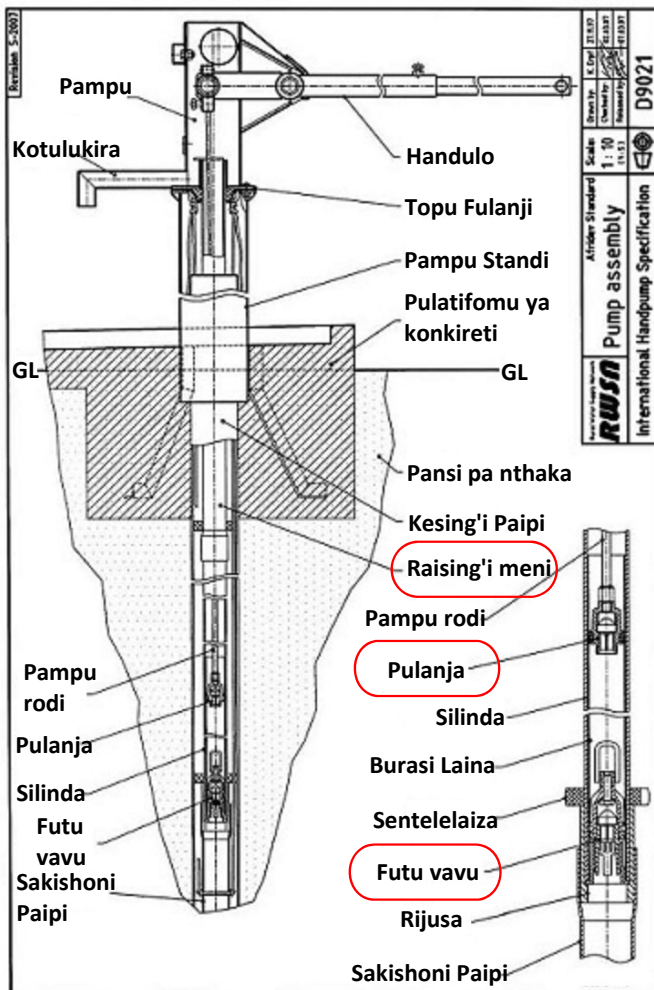
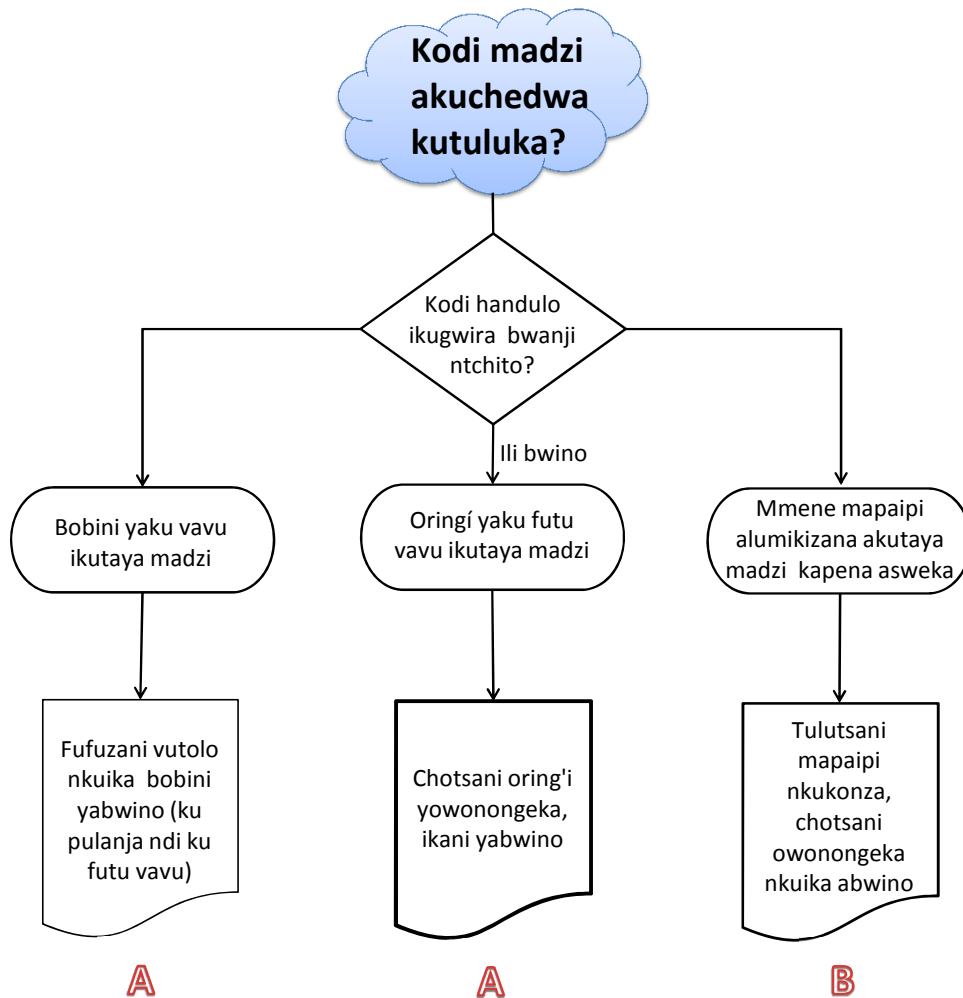

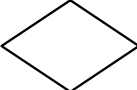
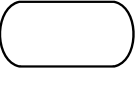

Matanthauzo azizindikiro

-  : Chofunika kuyang'ana
-  : Choyambitsa vuto
-  : Momwe mungakonzere

Kukula kwa Vuto

A: Akomiti okonza mjigo atha kukonza vutoli.



B: Nkofunika kuitana mekaniko waderalo kuti azakonze.

C: Nkofunika kuitana mlangizi wa za madzi kuti azakonze.

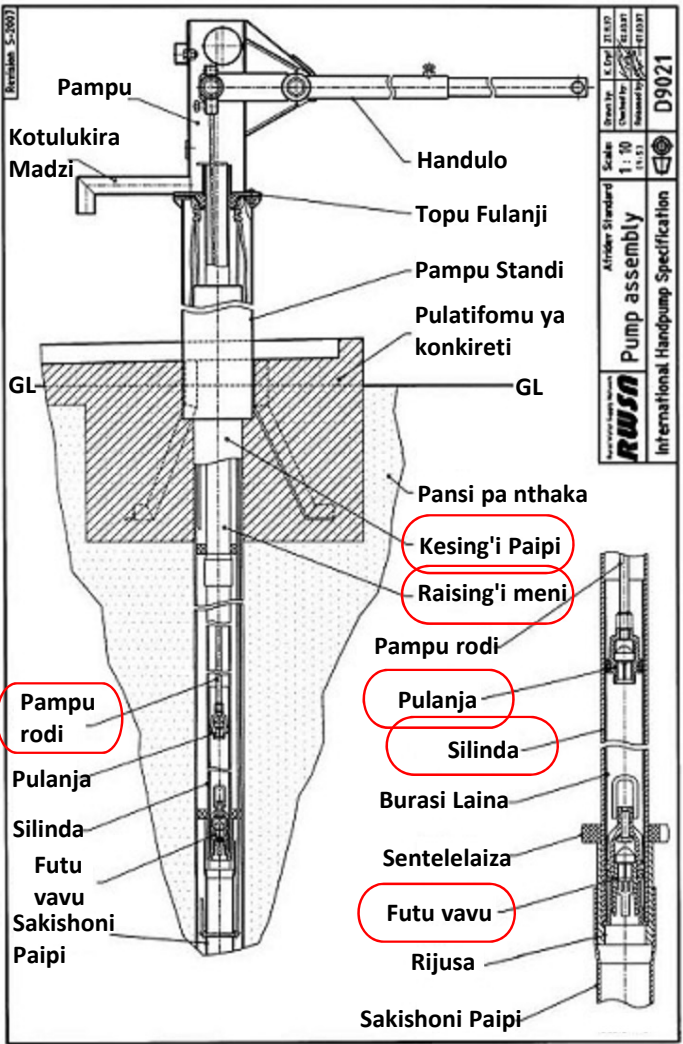
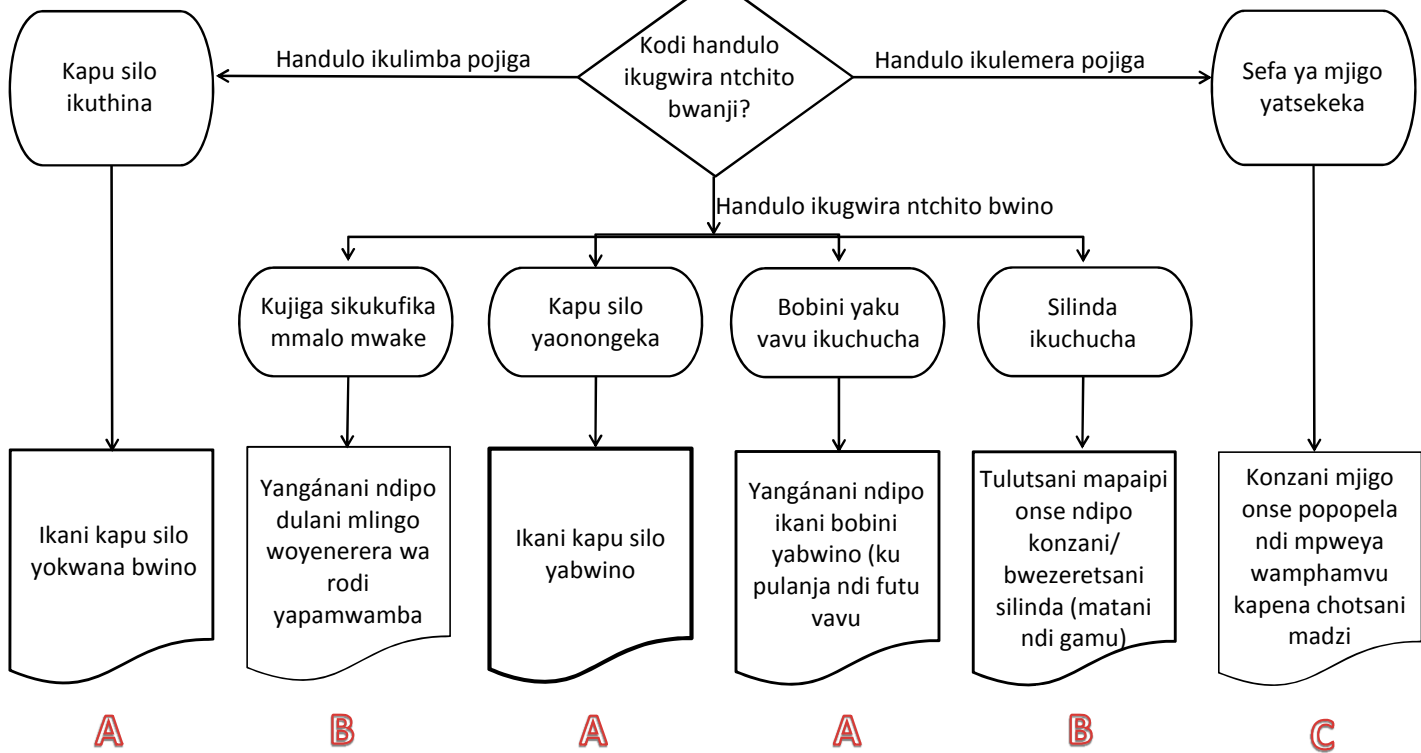
Kodi madzi akutuluka pang'ono pang'ono?

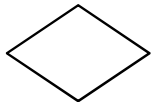
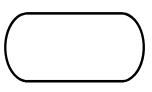

Matanthauzo azindikiro

-  : Chofunika kuyang'ana
-  : Choyambitsa vuto
-  : Momwe mungakonzere

Kukula kwa Vuto

- A:** Akomiti okonza mjigo atha kukonza vutoli.
- B:** Nkofunika kuitana mekaniko waderalo kuti azakonze.
- C:** Nkofunika kuitana mlangizi wa za madzi kuti azakonze.

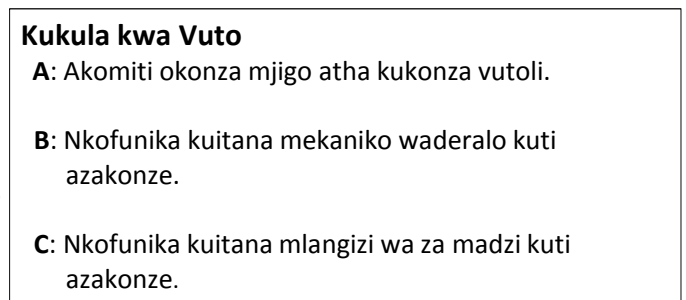
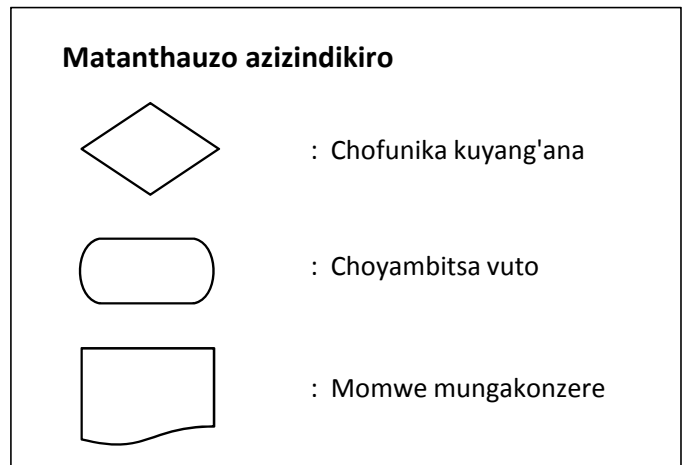
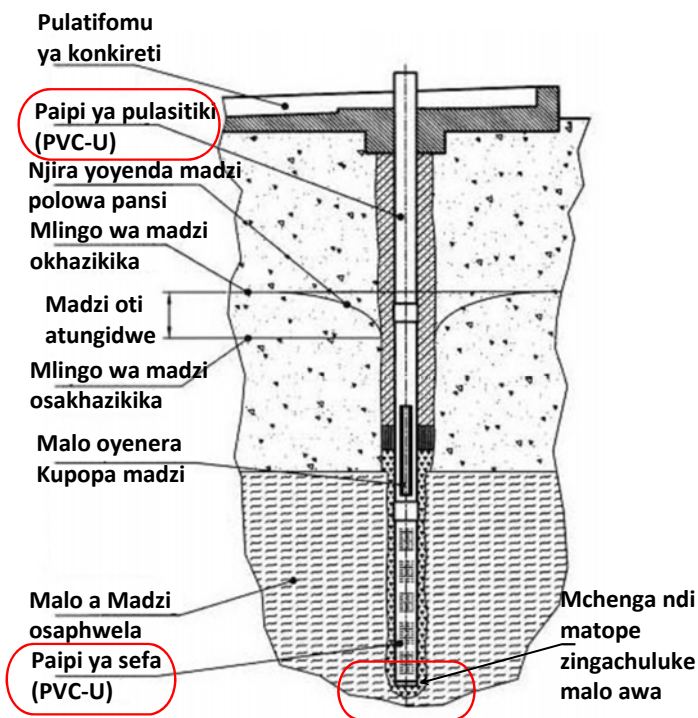
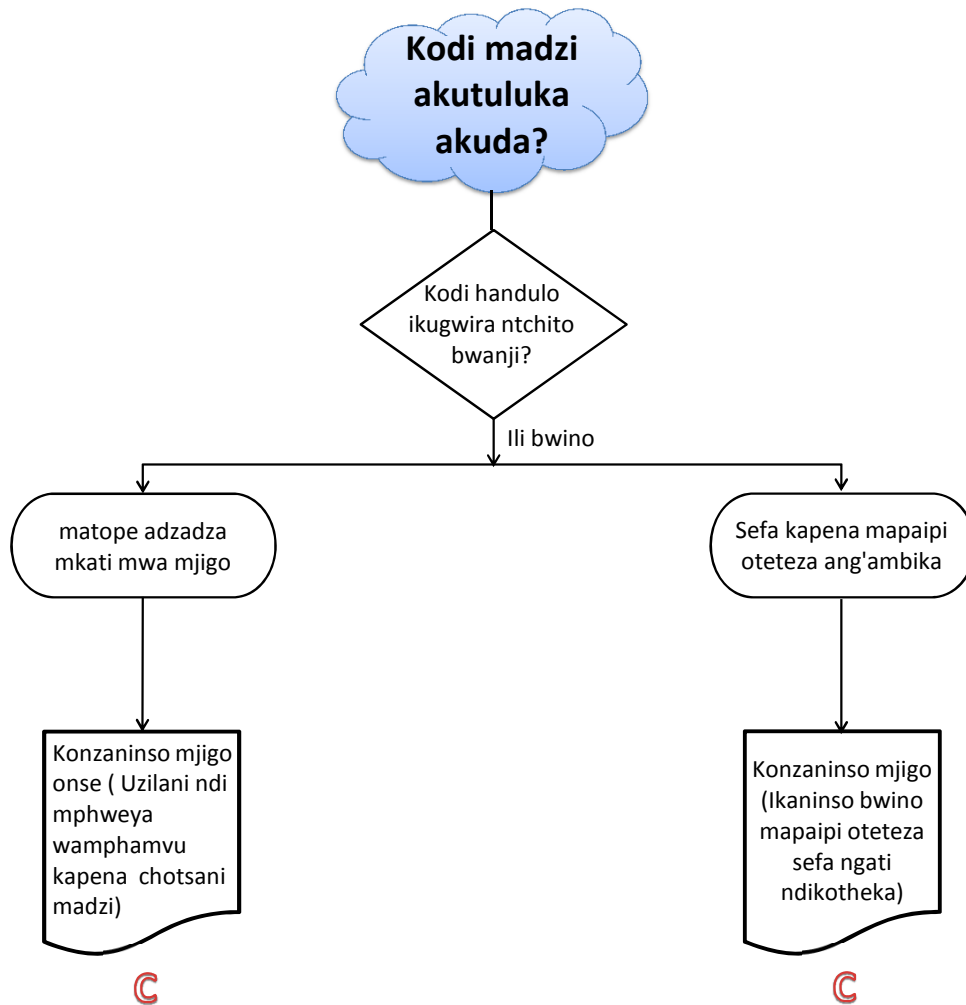

(Extracted from "Installation and mMaintenance Manual for Afridev Handpump, Rev. 2-2007, SKAT-RWSN")

Kodi madzi akukoma mchere kapena akumveka fungo?

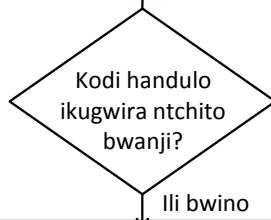

Nyansi za chimbuzi zalowa kudzera mming'alo ya chopondapo cha pamjigo

Konzaninso chopondapo (apuloni) ya pa mjigo

C

Madzi awonongeka ndi njira zoyendamo madzi za pansi

Wonani kuti chimbudzi nchotalikirana bwanji ndi mjigo. Siyani kuchigwiritsa ntchito ngati chili pamtunda wofupikira mamita 40 kuchokera pa mjigo

A

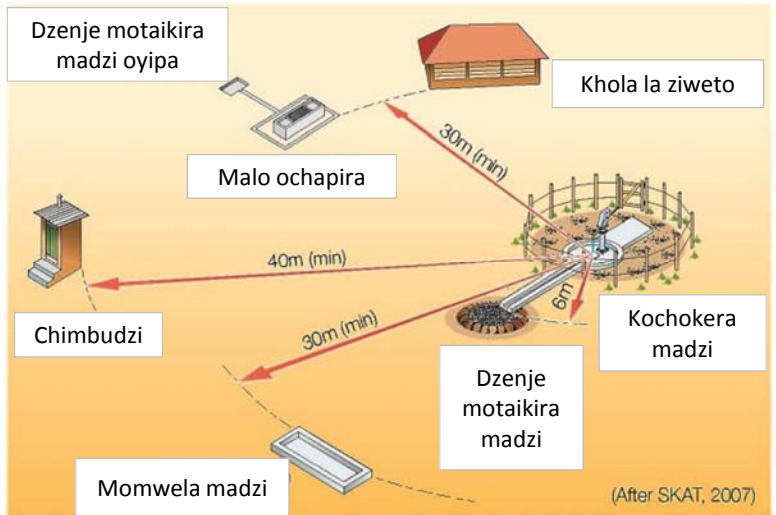
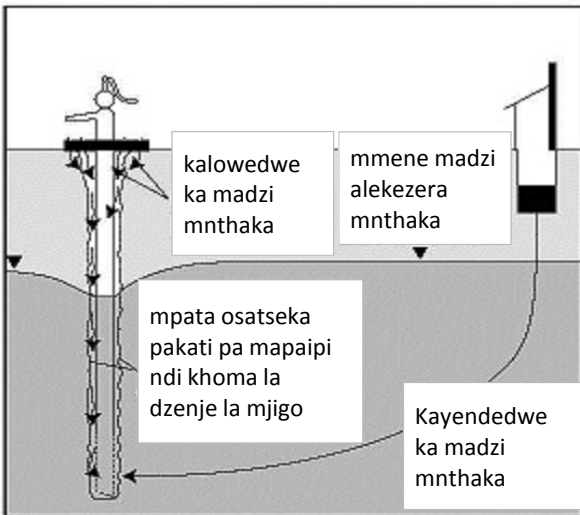

Matanthauzo azizindikiro

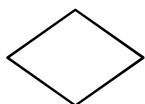

: Chofunika kuyang'ana

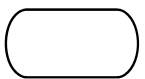

: Choyambitsa vuto



: Momwe mungakonzere

Kukula kwa Vuto

A: Akomiti okonza mjigo atha kukonza vutoli.

B: Nkofunika kuitana mekaniko waderalo kuti azakonze.

C: Nkofunika kuitana mlangizi wa za madzi kuti azakonze.

Kodi pakumveka phokoso lachilendo pojiga?

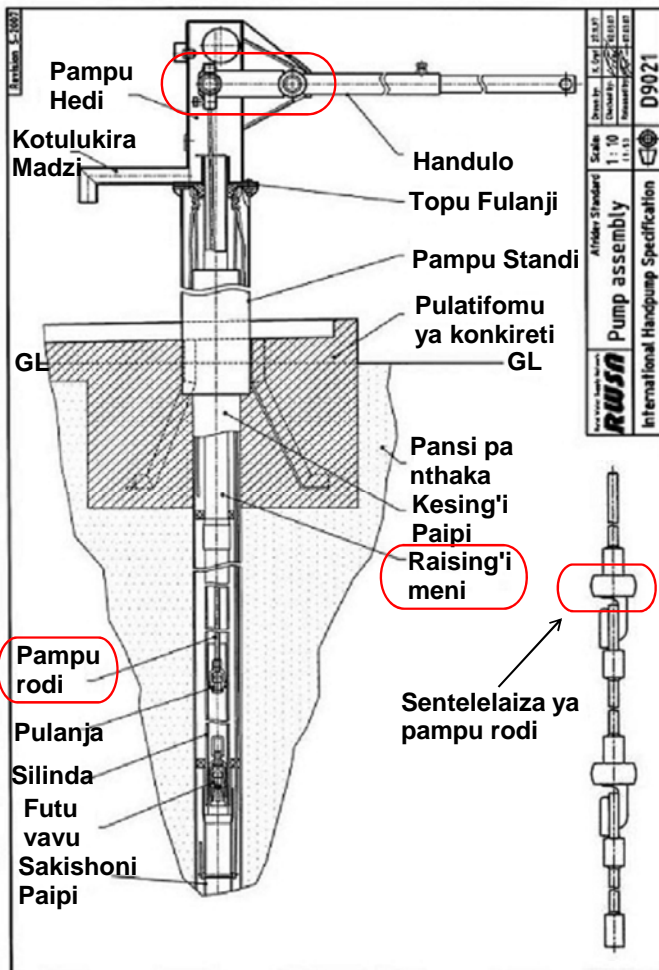
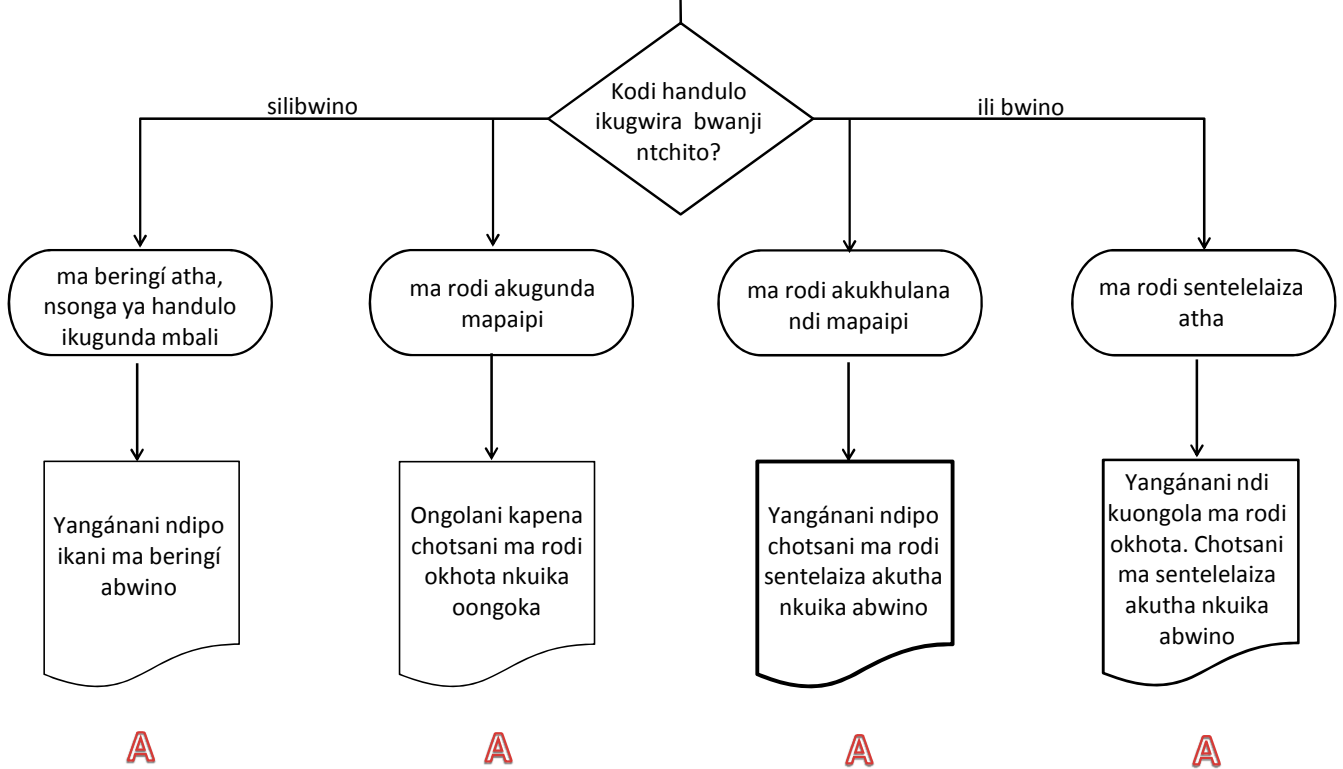

Matanthauzo azindikiro

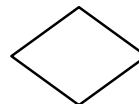

: Chofunika kuyang'ana

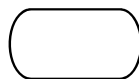

: Choyambitsa vuto



: Momwe mungakonzere vutolo

Kukula kwa Vuto

A: Akomiti okonza mjigo atha kukonza vutoli.

B: Nkofunika kuitana mekaniko waderalo kuti azakonze.

C: Nkofunika kuitana mlangizi wa za madzi kuti azakonze.

Kodi Handulo ikugwadera?

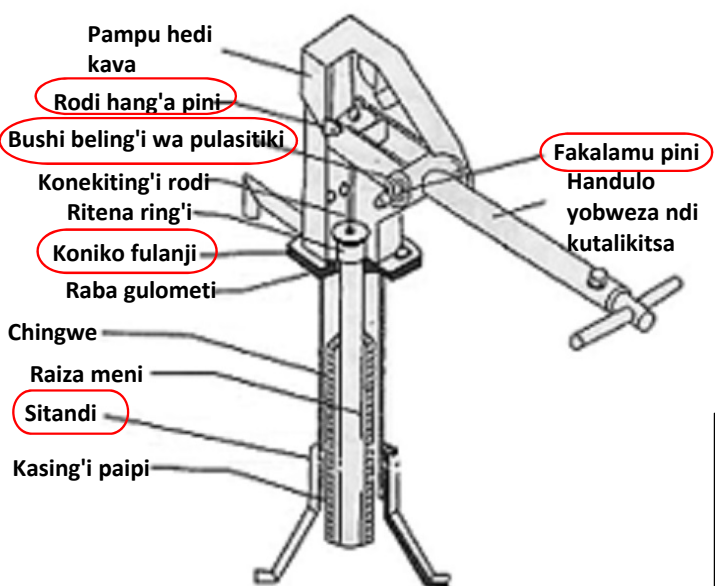
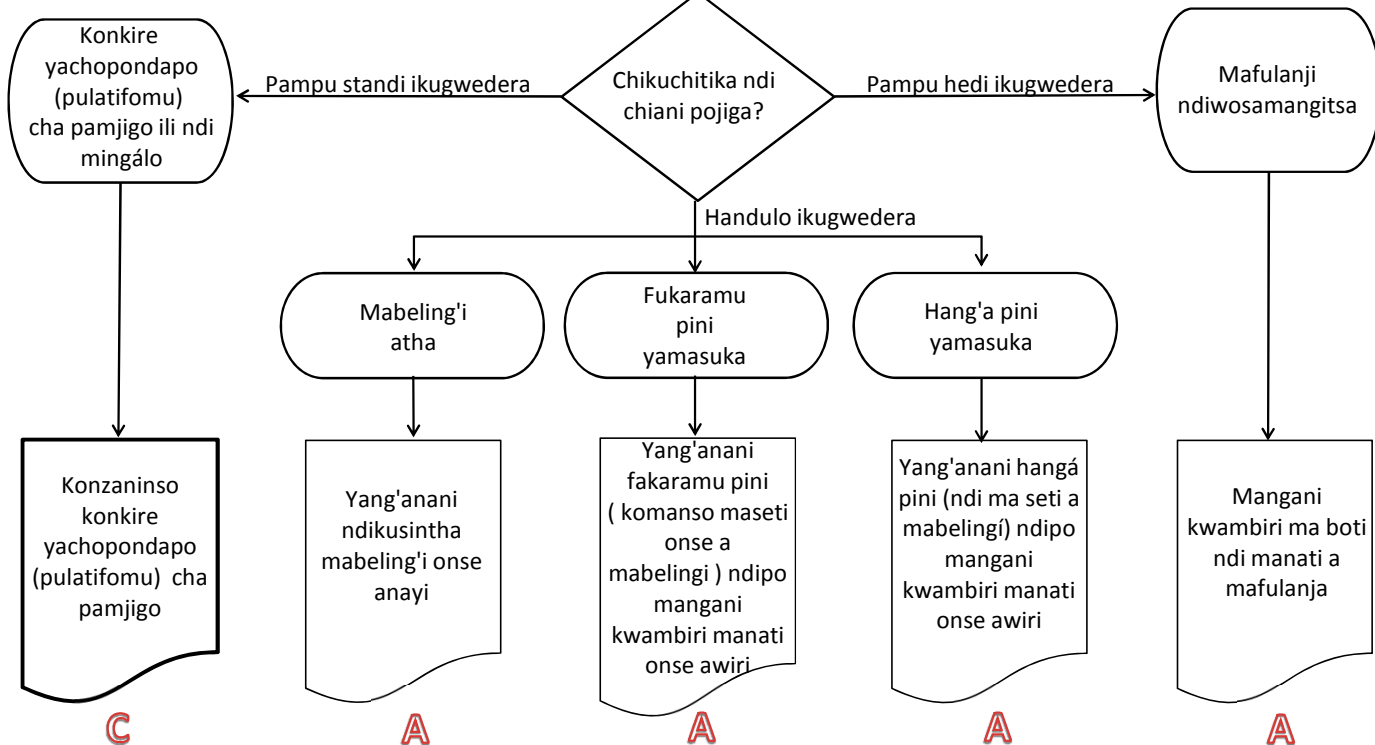

Matanthauzo azizindikiro

- : Chofunika kuyang'ana
- : Choyambitsa vuto
- : Momwe mungakonzere vutolo

Kukula kwa Vuto

- A:** Akomiti okonza mjigo atha kukonza vutoli.
- B:** Nkofunika kuitana mekaniko waderalo kuti azakonze.
- C:** Nkofunika kuitana mlangizi wa za madzi kuti azakonze.

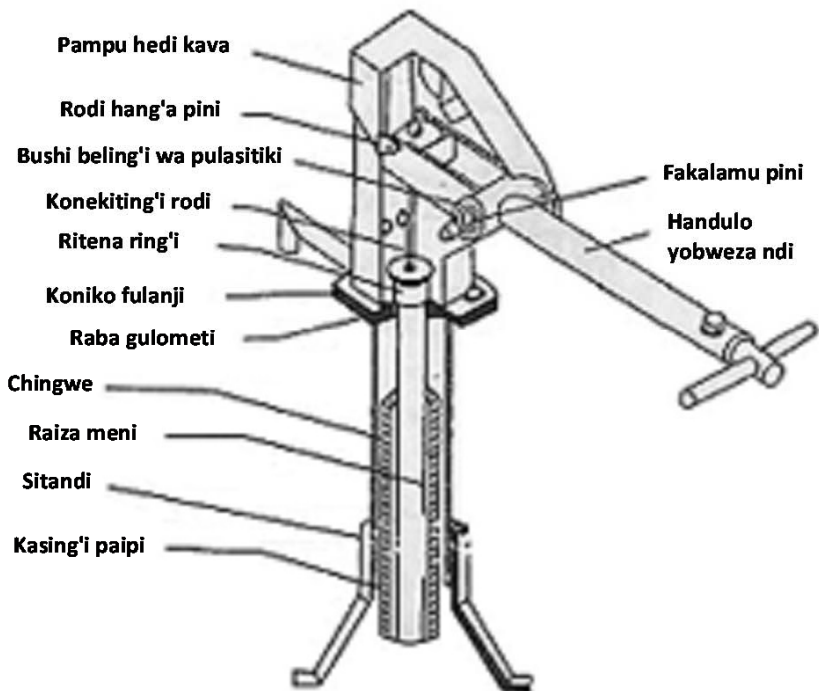

ALUMIKIZIDWE KA MJIGO

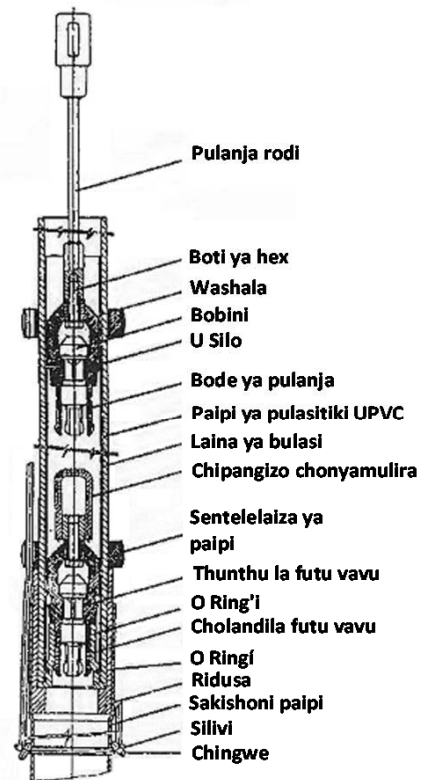

SILINDA ASEMBULE

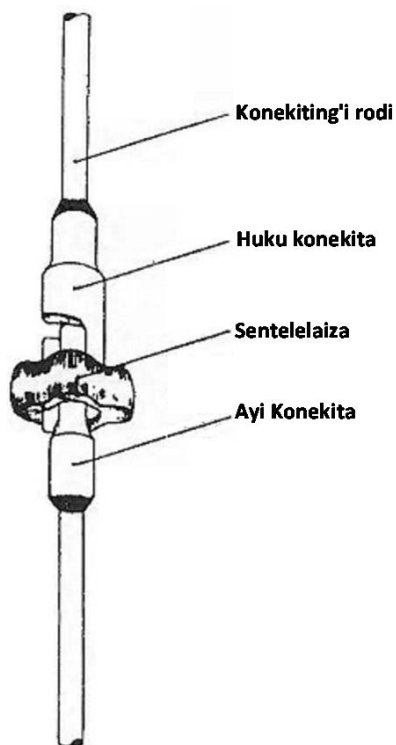

KONEKITING'I RODI ASEMBULE

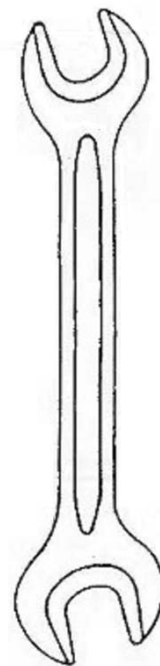

Sipanala yotsegula konse konse





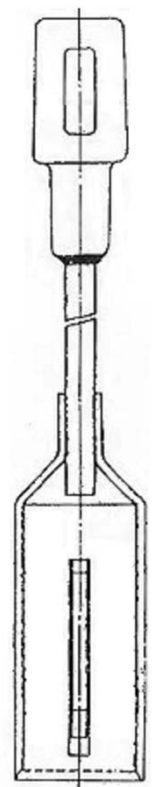







Sipanala ya soketi

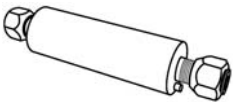

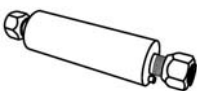

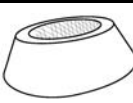
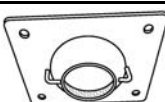
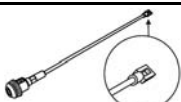

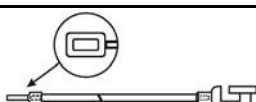
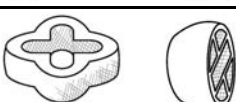



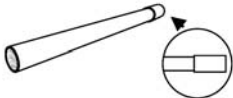

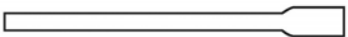

Mbedza yokolera ma rodi

TULU KITI YAPADERA

Mitengo ya zida za mjigo wa Afridev

No.	NAME OF PARTS		ILLUSTRATION
	ENGLISH	CHICHEWA	
1	Pump head & head cover	Hedi pampu chi vindikilo	
2	Pump stand	Pampu pedesitilo	
3	Pump handle	handulo	
4	Fulcrum pin	Falakamu pini	
5	Rodhanger	Hang'a Asembule	
6	Hanger pin	Hang'a pini	
7	Bush bearing	Bushi Belingi	
8	Rubber flapper	Labala Fulapa	
9	Rubber Cone	Labala koni	
10	Steel cone plate	Koni Puleti	
11	Brass plunger	Pulanja	
12	U-Seal for Plastic plunger	U-Silu	
13	Cup-seal for Brass plunger	Kapu-Silu	
14	Pumprod assembly	Pampu rodi	
15	Rod centralizer	Rodi Seneteleza	
16	Foot-Valve	Foot Valavu	
17	Bobbin	Bobini	

No.	NAME OF PARTS		ILLUSTRATION
	ENGLISH	CHICHEWA	
18	O-ring	O-ring'i	
19	Cylinder assembly	Silinda Asembule	
20	Suction pipe	Sakishoni paipi	
21	Riser pipe (PVC-U)	Mapaipi	
22	Riser pipe centraliser	Seneteleza wa ma paipi	
23	Top sleeve (collar)	Topu silivi	
24	Double end socket	Dabulo soketi	
25	Solvent cement	Soventisementi	
26	Nylon rope (6mm)	Chingwe	
27	Socket spanner	Spanara ya bowo	
28	Flat spanner	Spanara ya fulati	
29	Fishing tool	Mbedza	
30	Bolt & Nut (M12 x40)	Boti ndi nati (M12 x40)	

MAINA AMASHOPU ZIPANGIZO ZA MJIGO M'BOMA LA Mchinji (as of December 2013)

NAMBALA	DZINA LA SHOPU	MUDZI	NYAKWAWA	M'MENE ZILILI
1	Nkhuku Zipata	Bua Trading Centre	Mlonyeni	Selling
2	R.K. Hardware	Matutu Trading Centre	Mduwa	Selling
3	Victoria Shop	Kaigwazanga	Mkanda	Selling
4	Zuze Shop	Waliranji Trading Centre	Mavwele	Selling
5	Lester Hardware	Mikundi Trading Centre	Mduwa	Selling
6	Yanu Yanu	Kapiri	Dambe	Selling
7	Mkute Hardware	Mkanda	Mkanda	Selling
8	Robert Shop	Chiosya	STA Simphasi	Selling
9	Jacame Investment	Kamwendo	Zulu	Selling
10	Oliver Shop	Chithumba	Mavwele	Selling

MAYINA AMA MAKANIKI OKONZA MJIGO MBOMA LA (as of Dec. 2013)

Nambala	Dzina	Sex	Mudzi	Nyakwawa	Foni
1	S.Y. Pelete	Mwamur	Mng'ona	Mduwa	0995 654 157
2	Eftone Khwambala	Mwamur	Mikundi	Mduwa	0991 006 488
3	Edward Mawonga	Mwamur	Chakhalira	Mduwa	0996 736 288
4	Andrew Nkhoma	Mwamur	Mkanda	Mkanda	0999 674 505
5	Fanuel Sengani	Mwamur	Gumba	Mkanda	0884 367 050
6	George Mpalume	Mwamur	Chimombo	Mkanda	0993 116 470
7	Nelson Zidana	Mwamur	Chipumi	STA Kapondo	0993 116 468
8	Kasalika Josofati	Mwamur	Mthema	Dambe	0993 244 426
9	Edwin Chisiyesiye	Mwamur	Kangwere	STA Nyoka	0993 095 806
10	Nyongani Zulu	Mwamur	Mgumbo	Zulu	0884 041 026
11	Melkias Mumba	Mwamur	Benjamini	Zulu	0993 757 276
12	Aness Kalonga	Mkazi	Simphasi	STA Simphasi	0995 261 750
13	Jailosi Phiri	Mwamur	Menyani	Mlonyeni	0993 802 719
14	Fedeliko Jere	Mwamur	Mtukwa	Mlonyeni	0995 365 143
15	Jailosi Kubweza	Mwamur	Mose	Mlonyeni	0993 325 646
16	Hardwork Mvula	Mwamur	Geni	Mavwere	0999 235 138
17	Timoteyo Bayiwelo	Mwamur	Mkokha	Mavwere	0995 124 302
18	Seveliono Mayaya	Mwamur	Nathyola	Mavwere	0992 070 690
19	Hardson Marko	Mwamur	Kabuthu	Mavwere	0993 325 646
20	Alexander Kazinga	Mwamur	Mponda	STA Nyoka	0994 718 472
21	Oswald Khoza	Mwamur	Mlonyeni	Mlonyeni	

Tool 16



Sample designs for security system (Afridev Handpump Vesion)

Chitsanzo cha m'mene tingakonzere zotsekera m'mijigo ya mtundu wa Afridev kuti zipangizo zake zisabedwe.

CHITETEZO CHA MJIGO WA AFRIDEV M'MALAWI

Afridev ndi pampu yomwe imapezeka kwambiri m'midzi ya mdziko lino la Malawi chifukwa simavuta kuyika, kasamalidwe ndi kayendetsedwe komanso zipangizo zake sizimavuta kupezeka. Chifukwa cha kutalikira kwa mashopu amene amagulitsa zipangizo za mijigo, pampu ya Afridev imakhala pachiopezo chobedwa zipangizo m'madera. Pachifukwa ichi pali njira zina zotetezera mijigo kuti zipangizo zisamabedwe





M'mene mungakonzere loko wotsekera kuti mijigo isabedwe zitsanzo zake ndi izi zitatu zili musimu

<p>Choyamba: Mmene chitsanzo choyamba pa chinthunzi chimawonekera pa chinthuzi</p>	
<p>Chachiwiri: Mmene chitsanzo chachiwiri chimaonekera pa chinthuzi</p>	
<p>Chachitatu: Mmene chitsanzo cha chitatu chimaonekera pa chinthuzi</p>	

Kachitidwe kake :

Njira yoyamba

Poyamba : Gulani waya wa mtundu wa Y12 wotalika milingo 1.5m kapena 150cm ndi kumudula motore:

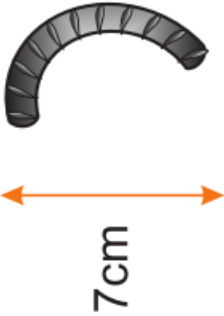
Nambala	Kufotokonzera	Chithuzi	Kuchuluka kwake	Nambala	Kufotokozera	Chithuzi	Kuchuluka kwake
1	Dulani waya mbali zonse ziwiri wakumanja ndi kumanzere milingo yokwana 36cm aliyense.		2	2	Dulani waya mbali zonse ziwiri wa milingo yokwana 18cm		2
3	Dulani waya ndikumupinda kwa milingo yokwana 10cm		1	4	Dulani waya ndikumupinda kwa milingo yokwana 18cm		1
5	Dulani waya ndikumupinda milingo yokwana 7cm		1				

Chachiwiri: KUOTCHERELA

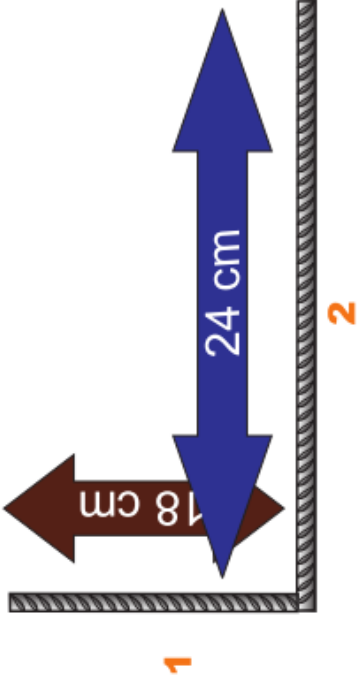
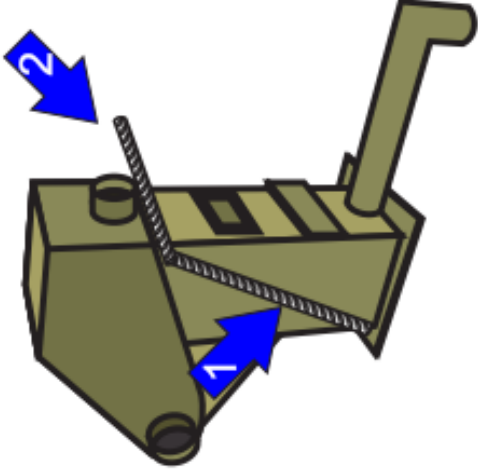
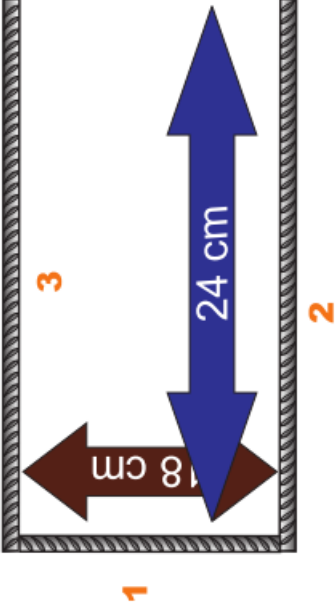
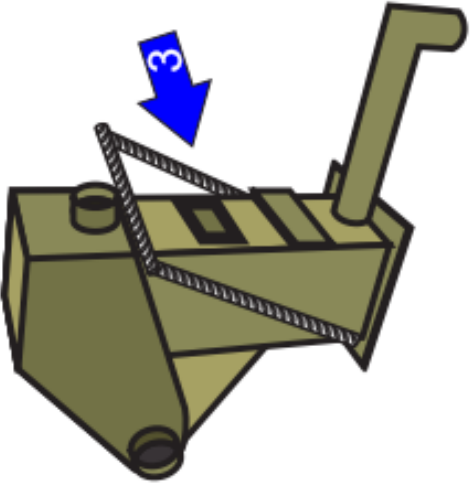
Nambala	Kufotokonzera	Chithuzi	Chithuzi chake
1	Wotchelerani poyamba zitsulo izi kuti mulumukize		
2	Wotchelerani kachiwiri chitsulo china mbali ina		

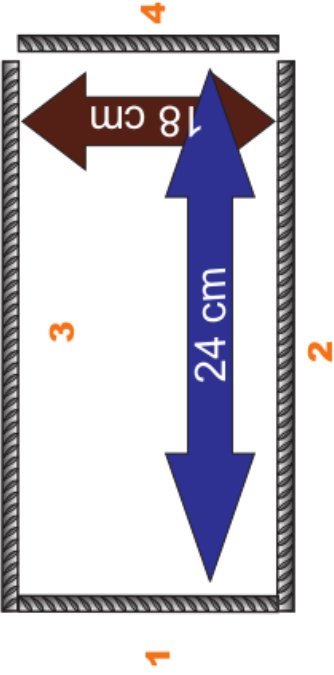
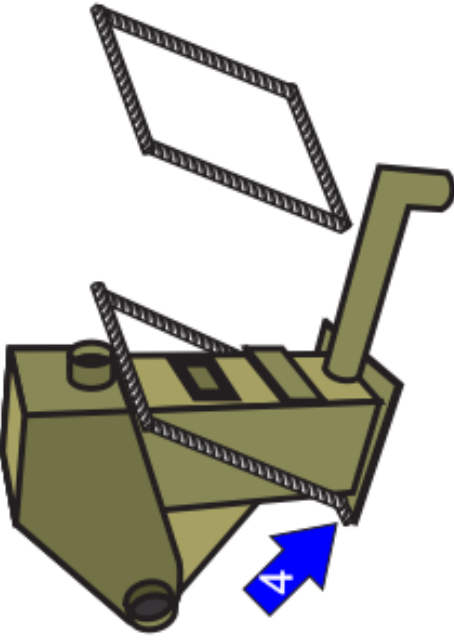
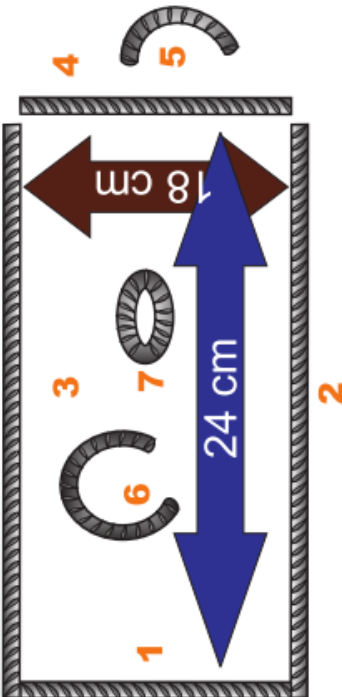
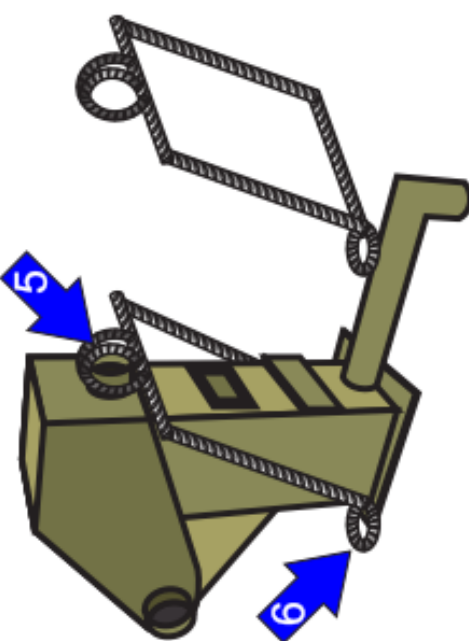
Nambala	Kufotokonzera	Chithuzi	Chithuzi chake
3	Wotchelerani chitsulo cha chitatu koma chachifupi		
4	Wotchelerani waya yomwe muzigwiritsa ntchito poloka		

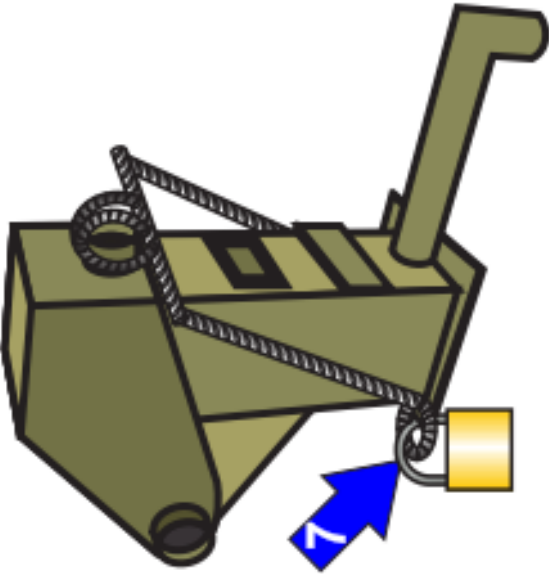
Nambala	Kufotokonzera	Chithuzi	Chithuzi chake
5	<p>Mukamaliza kuwotchelera yesani ngati pampu hedi kavala yasekedwa bwino ndi kuyesa kuseka ndi loko</p>		 <p>The diagram shows a mechanical assembly with a yellow cylindrical component at the bottom. A blue arrow points to this component, which is labeled with the number '7'. The assembly includes a green base, a coiled spring, and a handle-like structure extending upwards.</p>

Njira yachachiwiri

Poyamba: Kudula chitsulo ndi kugula

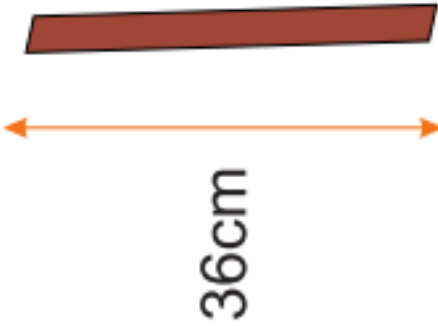
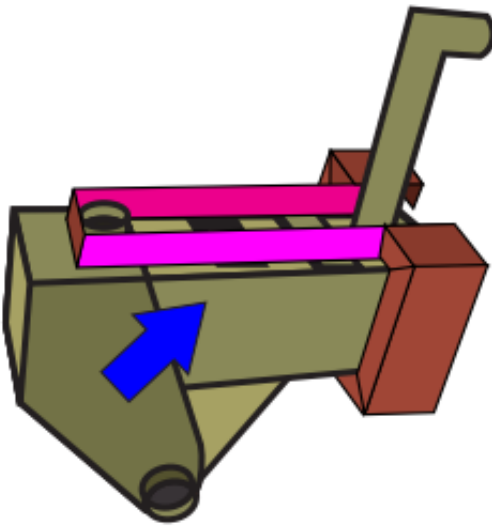
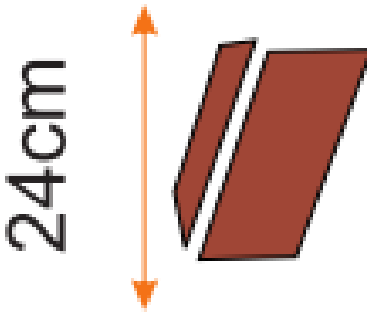
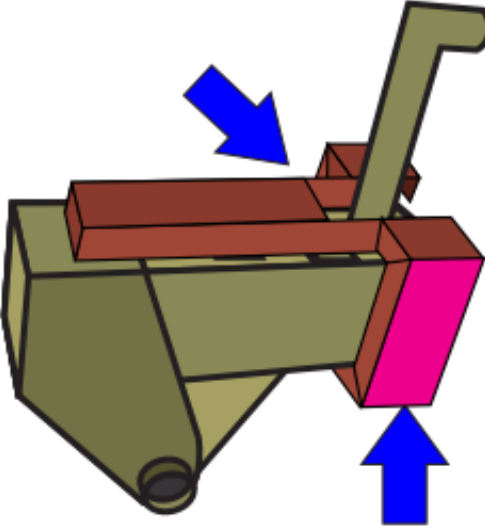
Nambala	Kufotokozera	Chithuzi	Kuchuluka kwake	Chithuzi chake
1	Dulani fulati shiti ya milingo yokwana 36cm kumanja ndi kumanzere zokwana zitatu	 <p>36cm</p>	3	
2	Dulani fulati shiti ina milingo yokwana 23.4cm	 <p>24cm</p>	1	

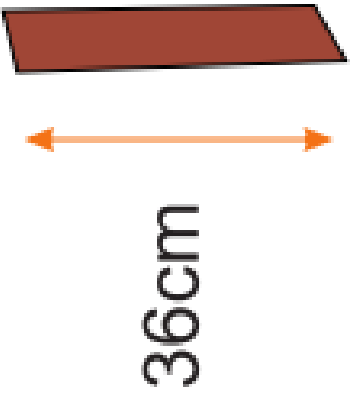
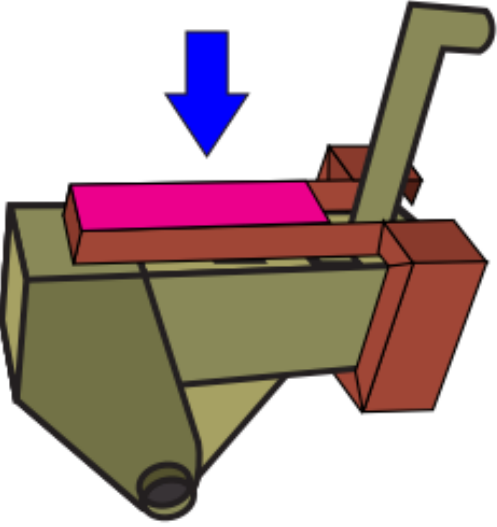
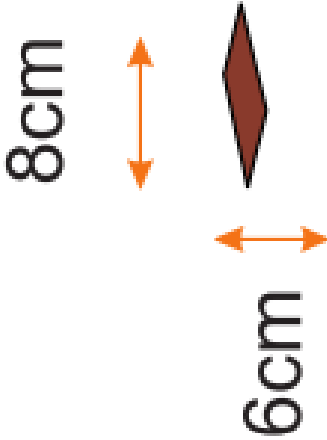
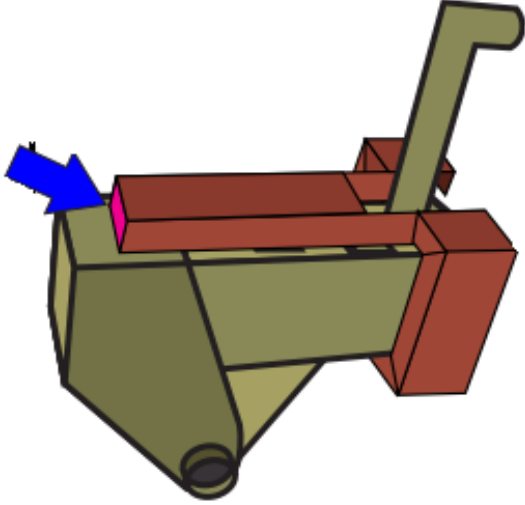
Nambala	Kufotokozera	Chithuzi	Kuchuluka kwake	Chithuzi chake
3	Dulani fulati shiti ina milingo yokwana 35cm	 <p>36cm</p>	1	
4	Dulani fulati shiti ina milingo yokwana 8cm multali ndipo 6cm mulifupi	 <p>8cm</p> <p>6cm</p>	1	

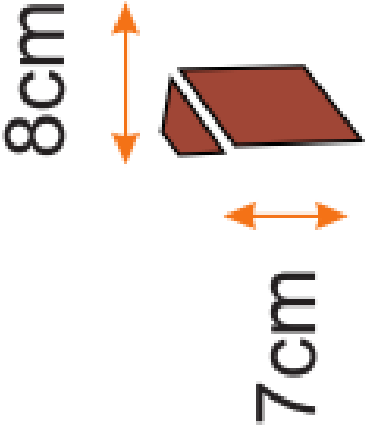
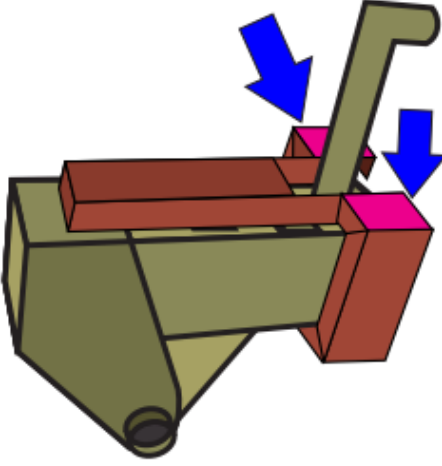
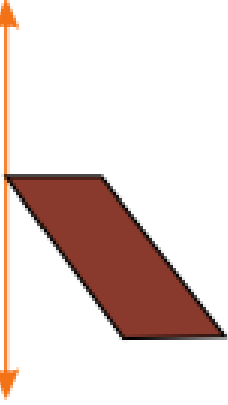
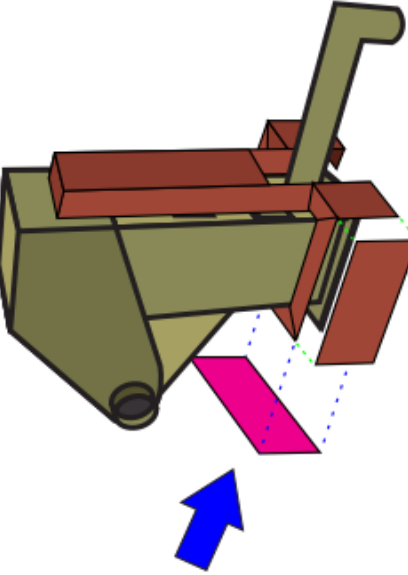
Nambala	Kufotokozera	Chithuzi	Kuchuluka kwake	Chithuzi chake
5	Dulani fulati shiti ina milingo yokwana 8cm multali ndipo 7cm mulifupi	 <p>8cm</p> <p>7cm</p>	1	
6	Dulani fulati shiti ina milingo yokwana 10cm	 <p>10cm</p>	1	

Chachiwiri: KUOTCHERELA

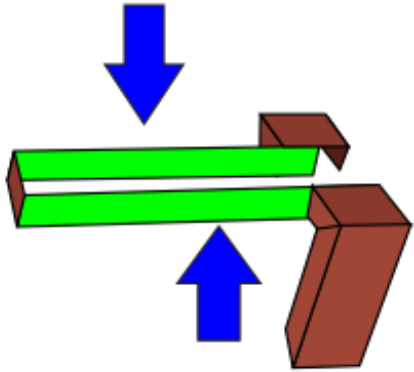
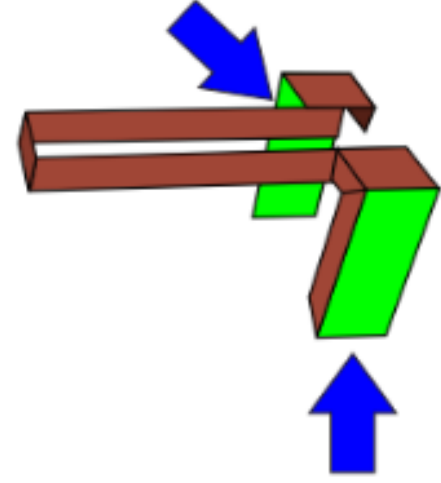
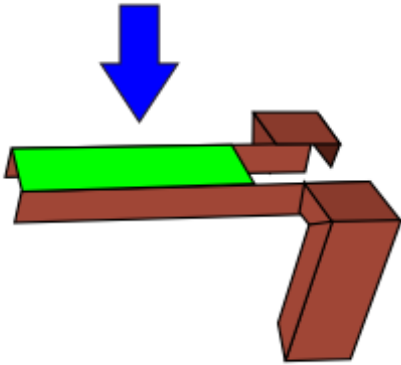
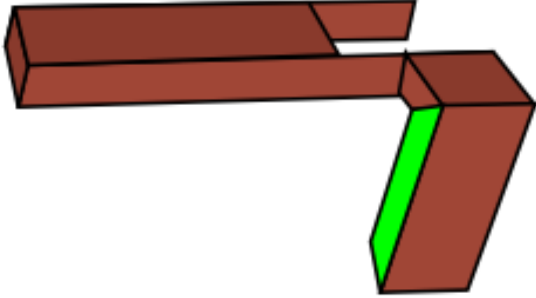
Nambala	Kufotokonzera	Chithuzi	Nambala	Kufotokozera	Chithuzi
1	Wotchelerani kaye mbali zitatu zonse za ma shiti a milingo yokwana 36cm ili yonse		2	Dulani waya mbali zonse ziwiri wa milingo yokwana 18cm	
3	Wotchelerani fulati shiti ya ma sentimenta okwana 24cm		4	Wotchelerani fulati shiti yomwe ndiyotalika milingo yokwana 35cm	

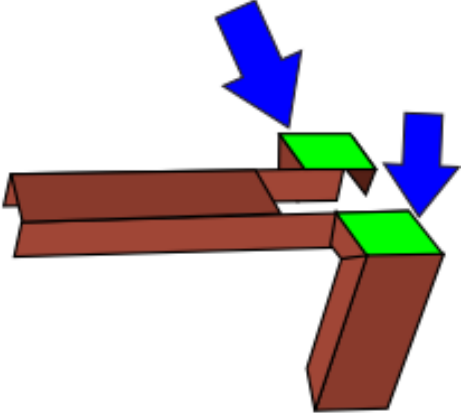
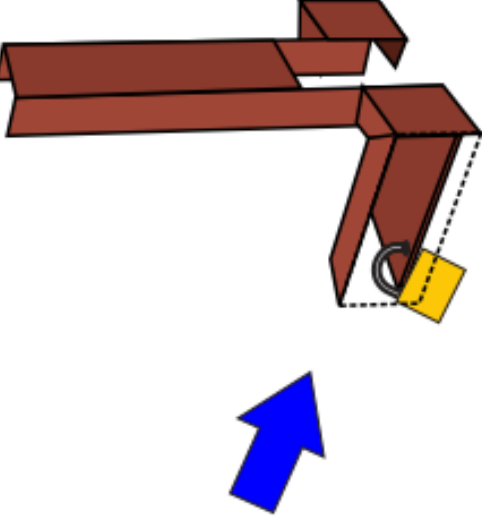
Nambala	5	Kufotokonzera	Wotchelerani fulati shiti ya milingo yokwana 10cm	Chithuzi		Nambala	6	Kufotokozera	Wotchelelani pokhamera makiyi kenaka tsekani ndi loko kenaka ma kiya asunge m' modzi wa akomiti kapena amene wayandikana ndi nyumba pa mjigo.	Chithuzi	
---------	---	---------------	---	----------	---	---------	---	--------------	---	----------	---

Njira yachitatu

Poyamba: Pezani mzigago (ngati muli zitsulo zakale nagti Beater ya mchigayo. Ku hardware, itha kupezeka pa mtengo wosiyanasiyana

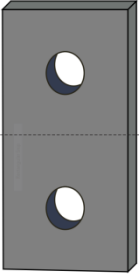
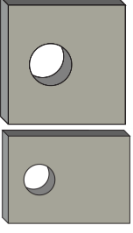
Nambala	Kufotokozera	Chithuzi	Kuchuluka kwake	Nambala	Kufotokozera	Kuchuluka kwake	Chithuzi
1	Dulani ma pisi a wili azitsulo		2	2	Dulani ma pisi a wili a zitsulo mulingo otere	2	

Chachiwiri: Kupeza ma pad lock awiri abwino

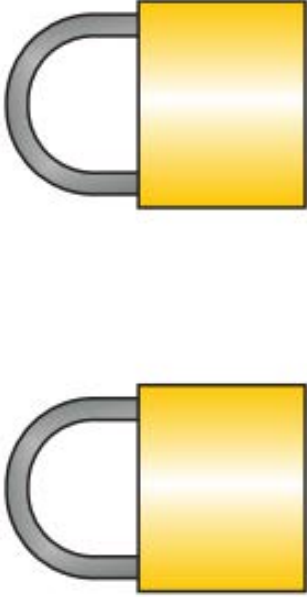
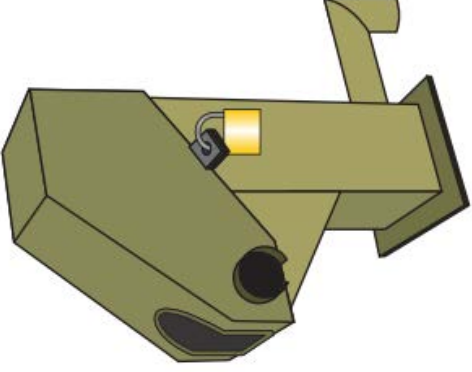
Nambala	Kufotokozera	Chinthunzi	Kuchuluka kwake
1	Funani ma padlock awiri, mulingo wake ukhale osachepera 55mn. Gulani ma padlocks(Nkofunika kwambiri kuyeseratu mukatha kuwotcherela)		

Chachitatu: KUOTCHERELA

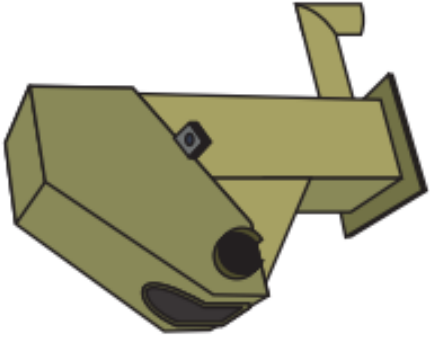
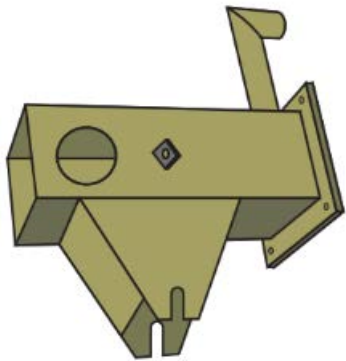
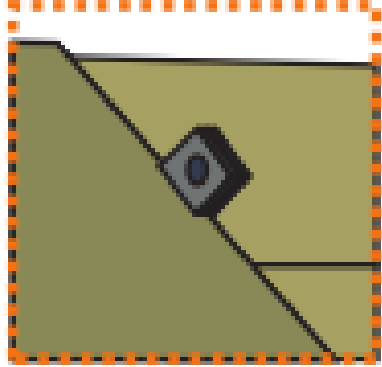
<p>Nambala</p> <p>1</p>	<p>Kufotokozera</p> <p>Wotcherelani poyambirila part yoyamba ku chotsekera pa pampu</p>	<p>Chithuzi</p> 	<p>Nambala</p> <p>2</p>	<p>Kufotokozera</p> <p>Ikani chotsekera mmalo mwake</p>	<p>Chithuzi</p> 
<p>Nambala</p> <p>3</p>	<p>Kufotokozera</p> <p>Pezani malo a pati ya chiwiri</p>	<p>Chithuzi</p> 	<p>Nambala</p> <p>4</p>	<p>Kufotokozera</p> <p>Kenako wotchelerani</p>	<p>Chithuzi</p> 

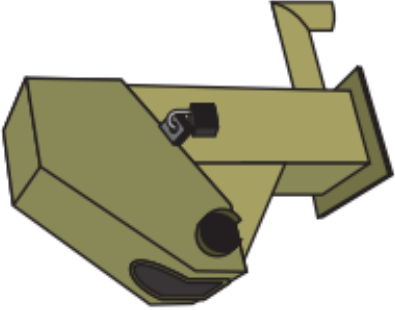
Nambala	Kufotokozera	Chithuzi	Nambala	Kufotokozera	Chithuzi
5	<p>Ikani mmalo mwake chotsekera ndipo ikani lock kuti muyese</p>				

Tool 17

Sample of Contract between WPC and AM

Chitsanzo cha Mgwirizano wa pakati pa akomiti yamadzi ndi Mekaniki wa dela.

MGWILIZANO

Numbering

pakati pa

Tsiku : _____

Mudzi / Mfumu yayikulu : _____

Mkonzi wa Dela : _____

Zoyenera kuchita (chongani mu kabokosi) :

Mgwirizano wapamwezi	Mgwirizano wapachaka	Zina
<input type="checkbox"/>	<input type="checkbox"/>	<input type="checkbox"/>

Mtundu wa ntchito : _____

Malipiro a wokonza wa Dela :

Zipangizo komwe zagulidwa : _____

Zipangizo zomwe zaikiwa	Mtengo wa zinthu	Zonse
	K	K
	K	K
	K	K
	K	K
	K	K
Zonse pa modzi		K

Wokonza wa Dela

Dzina:

Saini:

Oimira Mudzi

Dzina:

Saini:

¹ Note: This format is provided from InterAide.

Tool 18

Facility Management Plan Form

Fomu ya Ndongomeko ya m'mene tizisamalira pa mjigo wathu.

<Chitsanzo>

Dongosolo(Pulani) Mmene tingasamalire pa Mjigo

Chaka: 2013/2014

Dongosolo la kasamalidwe ndi kukonza Mjigo

Mudzi: Mtanga	Dzina la Mfumu: Mr. Jailosi Phiri
Mfumu yaikulu: Zulu	Boma: Mchinji

< Chitsanzo >

GAWO A: Kuchidziwa chitsime chathu

Boma: Mchinji	Mudzi: Maji village	Chiwerengero cha anthu onse akumwa mazi Pa mjigopo: 300
T/A: Zulu	Nambala ya Mjigo: Zu-23	Chiwerengero cha mabanja onse akumwa madzi pa Mjigopo: 60

Chiwerengero cha ma Ofesi onse akumwa madzi pa mjigopo: 0	Chiwerengero cha anthu ogwira ntchito mma Ofesi omwe akumwa madzi pa mjigopo: 0	Dzina la Ofesiyo/maofesiwo(S):

Gawo B-1: Komiti ya pa Mjigo/ komiti ya zaumoyo ndi madzi

Maina a mamembala a komiti	Mamuna/m kazi	Udindo Mkomiti	Ntchito yomwe amagwira	Tsiku lomwe anasankhidwa
1. Mr Chimanga Chagwa	Mwamuna	Wapampando	Kutsogolera ntchito zonse	12. Julaye 2005
2. Mrs Luntha Chuma	Mkazi	Wachiwiri kwa wa pampando	Kuthandiza kutsogolera ntchito zonse Kuitanitsa misonkhano	12. Julaye 2005
3. Mrs Fasileni Banda	Mkazi	Mlembi	Kulemba zokambilana pa nsonkhano ndi kupereka malipototi	12. Julaye 2005
4. Mr Zalimba Limitedi	Mwamuna	Wachiwiri kwa Mlembi	Kuthandiza Mlembi	12. Julaye 2005
5. Mrs Fadzai Chishalo	Mkazi	Msungji	Kuwerengetsera ndi kusunga ndalama	12. Julaye 2005
6. Mrs Zelina Belo	Mkazi	membala	Kutolera ndalama za nsonkhansonkha	12. Julaye 2005
7. Mrs Janipher Bauleni Lekani	Mkazi	Membala	Kuunika ntchito ya kusunga ndi kuwerengera ndalama mmene yayendera	12. Julaye 2005
8. Mr Zagwa Zatha	Mwamuna	Wokonza mjigo woyamba	Kukonza mjigo mwa apo ndi apo	12. Julaye 2005
9. Mr Zingalume Phulamtenga	Mwamuna	Wokonza mjigo wachiwiri	Kugula zipangizo za pa mjigo	12. Julaye 2005
10. Mrs Fane Wosamba Phiri	mkazi	Wokonza Mjigo wachitatu	Kukonza malo ozungulira Mjigo	12. July 2005

Kumbukirani: - Kuti akomiti akuyenera asankhidwe ndi anthu onse a mmudzi ndipo popanda chinyengo powonetsetsa kuti amayi komanso abambo ndiwochuluka mofanana komanso kuti amayi akupatsidwa mauidindo monga Msungi, wapampando kapena mlembi.

Gawo B-2: Ena olemkezeza Mmudzi

Dzina	Mamuna/ Mkazi	Udindo	Ntchito za anthuwa	Tsiku lomwe anasankhidwa
Mrs Diana Wodala Mbewe	Mkazi	Mifumu	Zosafunika kutchula	Zosafunika kutchula
Mr Zitha Banda	Mwamuna	Munthu wolemekezeka	Zosafunika kutchula	Zosafunika kutchula

Gawo C: Dongosolo la mmene tikonzere zinthu zolimbikitsa ukhondo pa Mjigo

Ntchito	Zufunika (anthu ogwira ntchito, Zida zogwiritsa ntchito, ndalama)	Tsiku lomwe tizamalize ntchito
Kumanga mpanda wa njerwa	Njerwa, simenti ,mchenga Zida zogwiritsa ntchito: Makasu, Shovelo, mpeni womangira. Woyangánira: Bambo...Chimanga Chagwa..... Ndalama zofunika: Titolera 100MK pa banja lililonse.	Tiyamba kumanga pa:31 August 2013, Tizamaliza mu: 31September 2013
Kumanga dzenje litaikira ra madzi kuyikamo miyala	Miyala yo phwany Wotsogolera ntchito ndi Mayi Fasileni Banda..... Zida zogwiritsa ntchito: Makasu, shovel ndi zina. Ndalama: Titolera 30MKpa banja lililonse.	Tiyamba kumanga pa: 20 August 2013, Tizamaliza mu: 20 September 2013
Kutchetcha p mjigo	Zotchetchera, masache	Titchetcha pa 20 August 2013

Kumbukirani: komiti ya pa mjigo ipange ndondomeko ya m'mene amangire zinthu zomwe ziiipamwambazi.

Gawo D: MALAMULO APA MJIGO

Udindo wa anthu onse a m'mudzi(kuphatikizapo kukonza dongosolo losesa pa mjigo

- Kusonkha ndalam za pa mjigo

- Wosasonkha aasamwe madzi
- Osatunga madzi usiku
- Aliyense akuyenera kutengapo mbali pa nkhani yokonza ndi kusamalira pa Mjigo
- Mjigo uzitsekedwa 7 koloko madzulo
- Madzi ndiwogwiritsa ntchito zapakhomo pokha osati zina.
- Ziweto siziloledwa kumwa pa mjigo
- Kusamba mkosaloledwa pa mjigo
- Kuchapa pa mjigo mkosaloledwa
- Ana saloledwa kusewera pa mjigo

Kukhazikitsa mtengo wosonkha pa mjigo: Banja lililonse lisonkha 100MK pa mwezi kapena chimanga chochulukuka molingana ndi mtengo wosonkha

Njira yo sungira ndalama : Mu bokosi la Msungu

Gawo E: DONGOSOLO LA NTCHITO NDI MMENE NDALAMAZIGWIRIRE NTCHITO

GAWO	NTCHITO	KANGATI	ZOFUNIKA (ANTHU, ZIDA, CHUMA)	NDALAMA ZOMWE ZAGWIRITSIDWA NTCHITO PA MWEZI
Zosamalira ndi kuyangánila	Nsonkhano wa anthu onse ndi akomiti kutsatila kuunika zomwe akwaniniritsa.	Pa miyezi itatu iliyonse	Mitu ya zokambirana, Kope , Cholembera, Akomiti, Anthu onse a mmudzi	MK 10,000
	Kukonzanso ndandanda wa anthu omwe amamwa pa mjigo	Pa chaka chilichonse	Kope, cholembera, Akomiti, Amfumu, Anthu onse am'mudzi	MK 1,000
	Kalondolondo wa ntchito zonse	Pa miyezi itatu iliyonse	Kope, Cholembera, Akomiti	MK 2,000
	Kukonza ndondomeko ya pa chaka	Pa chaka chilichonse	Mitu ya Zokambirana, Akomiti, Amfumu, Anthu onse am, mudzi	MK 1,000

GAWO	NTCHITO	KANGATI	ZOFUNIKA (ANTHU, ZIDA, CHUMA)	NDALAMA ZOMWE ZAGWIRITSIDWA NTCHITO PA MWEZI
Kukonza ndi kuiikila zipangizo zoonongeka pa mjigo	Kukonza kwa apo ndi apo	Pasabata kapena pa miyezi itatu iliyonse	Akomiti, Zipangizo zatsopano za Mjigo, Sipanala ya bowo, Ndalama.	Mk 15,000
	Kugula zipangizo za pa mjigo	Pa miyezi sikisi iliyonse(Theka la chaka)	Ndalama, Akomiti	MK 20,000
	Mgwirizano wa pa chaka ndi M' misili	Pa chaka chilichonse	Akomiti, Makaniki, Pepala la Mgwirizano, Ndalama	MK 4,500
Kusamalira za chilengedwe	Kumangila Mjigo mpanda	Pa Zaka ziwiri zilizonse	Akomiti, zipangizo zo mangila mpanda, Anthu onse ammudzi, Ndalama, Zida zogwiritsira ntchito	MK 150,000
	Kudzala mitengo	Muganiza nokha	Akomiti, Anthu onse a mmudzi, Ndalama, zida zogwiritsira ntchito, kope cholemba	MK 10,000
	Kukonza ndi kulambulira ngalande za mjigo	Pa Zaka ziwiri zilizonse	Akomiti, zipangizo zo mangila mpanda, Anthu onse ammudzi, Ndalama, Zida zogwiritsira ntchito	MK 8,000
	Kukonza ndi kulambulira dzenje lotaikiramadzia.	Pa Zaka ziwiri zilizonse	Akomiti, zipangizo zo mangila mpanda, Anthu onse ammudzi, Ndalama, Zida zogwiritsira ntchito	MK 5,000
	Zinthu zomwe zingapangitse kuti madzi athu awonongeke (Kutalikira kwa Chimbuzi, dzenje la zinyalala, khola la ziweto, munda kuchokera pa mjigo.	Pa chaka chilichonse	Akomiti, Amfumu, Anthu onse Ammudzi, kope cholemba	MK 1,000

Gawo E: KASHI BUKU (Mwachidule pa chaka chilichonse)

TSIKU	NDALAMA ZOMWE ZILIPO		NDALAMA ZA KU BANKI		ZOTSALA	
	ZLOWA	ZOTULUKA	ZLOWA	ZOTULUKA	NDALAMA ZOMWE ZILIPO	NDALAMA ZA KU BANKI
Disembala 2012	100,000MK	200,000MK	-	-	800,000MK	-
Disembala 2013	850,000MK	300,000MK	-	-	1,550,000MK	-
Disembala 2014	110,000MK	500,000MK	-	-	2,050,000MK	-

Mmalo mwa Komiti yonse

Saini.....

Tsiku.....

Tool 19

Action Plan Form

Fomu ya Ndongomeko ya zomwe tichite potukula pa mjigo wathu

NDONDOMEKO YA ZOMWE TICHITE POSAMALIRA PA MJIGO WATHU

BOMA:	MFUMU YAYIKULU:	MUDZI:	NAMBALA YA MJIGO:
--------------	------------------------	---------------	--------------------------

Tsiku	Ntchito	Zida zofunikira	Oyenera kuchita ntchitoyo	Nthawi yomwe tigwirire ntchiyo	Wotsogolera Ntchito	Ndemanga
25/07/2014	Kumanga mpanda wamatabwa	Matabwa, MISOMALI, Saha/Macheke, Nyundo.	Anthu onse a m'mudzi	Sabata imodzi	Bambo Kautsi	
26/07/2014	Kukhazikitsa mtengo wolipira Madzi	Nsonkhano wa mudzi wonse	Akomiti, mfumu, ndi mudzi wonse	Masana	Akomiti motsogozedwa ndi a Mfumu	
27/07/2014	Kumanga dzenje lotaikila madzi	Miyala, mchenga, njerwa, simenti	Anthu onse a m'mudzi motsogozedwa ndi akomiti	Masiku awiri	Akomiti	
28/07/2014	Kutolera ndalama za pa mwezi	Book la msonkhansonkha	Akomiti ndi anthu onse	Masiku atatu	Akomiti	

NDONDOMEKO YA ZOMWE TICHITE POSAMALIRA PA MJIGO WATHU

BOMA:	MFUMU YAYIKULU:	MUDZI:	NAMBALA YA MJIGO:
--------------	------------------------	---------------	--------------------------

Tsiku	Ntchito	Zida zofunikira	Oyenera kuchita ntchitoyo	Nthawi yomwe tigwirire ntchiyo	Wotsogolera Ntchito	Ndemanga

Tool 20

WPC Meeting Agenda and Checklist

Mitu ya zokambirana ndi mfundo zomwe zakambidwa pa msonkhano wa komiti ya madzi ndi mudzi wonse.

ZOKAMBIKANA PA NSONKHANO WA KOMITI YA MADZI NDI ANTHU A MMUDZI

Mfumu yaikuluMudzi.....

Nambala ya Mjigo

Dzina la Mlembi:.....Tsiku:.....

Zokambirana Zoyenera Pa msonkhano wa Komiti ya Madzi		Chongani eya kapena ayi ngati mwakabirana mitu ili kumanzereyi	
Mitu ya Zokambirana		Eya	Ayi
a. Tizipereka kangati ndalama za nsonkhansonkha wa madzi			
b. Tsiku lotolera ndalamayo			
c. Njira za kaperekedwe (Ndalama kapena zinthu)			
d. Banja lililonse lizisonkha ndalam zingati			
e. Njira ya katoleredwe ka ndalama (Kuyendera khomo ndi khomo, pa Mjigo, ndi zina)			
f. Kasungidwe ka chuma cha pa Mjigo (ku Banki, Amsungi apamjigo,kuguliratu zipangizo zotha mnsanga, ndi zina).			
g. Malamulo ndi zilango kwa iwo osapereka ndalama za pa mjigo.			
h. Kusamutsa zinthu zomwe zingapangitse madzi apa Mjigo kuonongeka(monga zimbuzi, dzenje la zinyalala, Khola la ziweto, Bafa, minda, manda, ndi zina zotero) zomwe zili pa mtunda wosapyola malipande (30) kuchokera pa mjigo wathu (maka pa zitsime zakuya ngati za Afridev) ndipo pa mtunda wosapyola zana limodzi (100)(maka pa zitsime zokumba ndi manja monga Pampu ya Malda).			
i. Kukonza dongosolo la kasesedwe ka pa mjigo lomwe limayenera kukhala ndi zinthu ngati izi: i). Dzina la amene/gulu asese tsiku limenelo.ii) Azisesa kangati(mwachitsanzo kusesa ndi kukolopa tsiku lilonse, kutsuka miyala ya dzenje lotayikila madzi a pa mjigo sabata iliyonse. iii). chilango kwa iwo osatsatila dongosolo lokonza pa mjigo.			
j. Kukonzanso konkiriti monga ming'alu ndi maenje kuti pa mjigo			
k. Pasakhale zithaphwi.			
l. Kupanga chiganizo pa mtundu wa mpanda ndi dzenje womwe tingamange kapena kukonzanso.			
m. Kufunika kokhala pa mgwirizano ndi Mmisili wa dela ndi mtundu wa mgwirizanowo(monga wa pachaka kapena wa nthawi yomwe Mkaniki wa dela wakonza mjigo.			
n. Dongosolo la m'mene tigulire zipangizo za pa mjigo(akomiti azisungira zipangizo zotha msanga pa mjigo).			
o. Lembani ntchito zonse zomwe zavomerezedwa mu" ndondomeko ya			
p. M'mene mjigo wathu usamalidwile"powonetsa izi: i) zofunika, ii). Wotsogolera ndi iii). Nthawi yomwe ifunike kuti tigwire ntchitoyo.			
Anthu omwe analipo pa nsonkhano		Abambo:.....	Amayi.....

Tool 21

Monitorinig Form

Fomu ya kalondolondo

Nambala ya Mjigo:	Mfumu yaikulu:
Mudzi:	Tsiku/ Nthawi:
Mlangizi wa za umoyo wa Dela:	
Mfumu ya m' mudzi:	
Wapampando wa komiti:	
Munthu Wolemekezeka:	
Nambala ya mabanja:	
Q1	Kodi msonkho wa madzi unakhazikitsidwa? <input type="checkbox"/> Eya <input type="checkbox"/> Ayi, Chifukwa? ➤
Q2	Banja lilonse limasonkha ndalama zingati? Ndipo kangati? ➤ MK /pa banja: Kangati
Q3	Ndi mabanja angati omwe asonkha kale?
Q4	Ndalama zonse zomwe mwasonkhetisa panopa ndi zingati? ➤ MK
Q5	Kodi mumagwiritsa ntchito buku la msonkhamsonkha polembera mabanja omwe apeleka msonkho wa madzi? <input type="checkbox"/> Eya <input type="checkbox"/> Ayi, Chifukwa?: ➤
Q6	Kodi mumagwiritsa ntchito Kashi Buku powonetsa ndalama zolowa zotuluka and zotsala? <input type="checkbox"/> Eya <input type="checkbox"/> Ayi, Chifukwa? ➤
Q7	Kodi akomiti kuphatikizapo anthu onse adawonetsa chidwi chomanga mpanda kapena dzenje lophwetsela madzi pambuyo pa maphunziro awo? <input type="checkbox"/> Eya pa zonse ziwiri; <input type="checkbox"/> Mpanda wokha; <input type="checkbox"/> Dzenje lokha ➤
	<input type="checkbox"/> Ayi, Chidwi chanji chinasonawacho?

➤	
Q8	Kusintha komwe kulipo pa mpanda wa pa mjigo mkotani? <input type="checkbox"/> Womangidwa kumene; <input type="checkbox"/> Wokonzedwanso <input type="checkbox"/> Zina(); <input type="checkbox"/> Palibe kusintha kulikonse
Q9	Kusintha komwe kulipo pa dzenje lotaikira madzi apa mjigo mkotani? <input type="checkbox"/> Lomangidwa kumene; <input type="checkbox"/> Repaired/Maintained <input type="checkbox"/> Zina(); <input type="checkbox"/> Palibe kusintha kulikonse
Q10	Kodi malo ozungulira pa mjigo pamaseseḍwa motsatila ndondomeko yomwe inakonzedwa? <input type="checkbox"/> Eya <input type="checkbox"/> Ayi, Chifukwa?
Q11	Kusintha komwe kwaoneka pa zinthu zomwe zingapangitse madzi apamjigo kuwonongeka? Chimbudzi <input type="checkbox"/> chachotsedwa <input type="checkbox"/> Palibe kusintha <input type="checkbox"/> sizikugwirizana Dzenje la zinyalaa: <input type="checkbox"/> Lakwiriḍwa <input type="checkbox"/> Palibe kusintha <input type="checkbox"/> sizikugwirizana Khola la ziweto: <input type="checkbox"/> lachotsedwa <input type="checkbox"/> Palibe kusintha <input type="checkbox"/> sizikugwirizana Munda: <input type="checkbox"/> Adasiya kulima <input type="checkbox"/> palibe kusintha <input type="checkbox"/> sizikugwirizana Kusintha kwina kulikonse:.....
Q12	Kodi mulinazo zipangizo za pa mjigo zoguliratu? <input type="checkbox"/> Eya, Ziti? <input type="checkbox"/> Ayi ➤
Q13	Kodi akomiti amatha kukonza kapena kusintha zipangizo zomwe zatha pa mjigo? ➤ Kuunika mjigo pa sabata iliyonse: <input type="checkbox"/> Eya <input type="checkbox"/> Ayi ✓ Kuwona ngati ma nati ndi mabauti ndiwosamasuka ✓ Kuwona ngati ma nati a pin wa mfupi and wantali ndiwosamasuka ➤ Kuunika pa mwezi uliyonse: <input type="checkbox"/> Eya <input type="checkbox"/> Ayi ✓ Kuwona ngati ngati pali mbali zomwe zikusowa mutu wa Mjigo. Kuwona ngati Mjigo ukuchita phokoso pojiga ✓ Kuwona ngati thunthu la Mjigo likugwera pojiga. ✓ Kuwona ngati madzi akutaika m' mapaipei
Q14	Kodi mumamudziwa Makaniki wokonza mjigo wa dela lino? <input type="checkbox"/> Eya, Dzina..... <input type="checkbox"/> Ayi

Q15 Kodi mukudziwa kumene kuli ma shop ogulitsa zipangizo za mjigo?
 Aya..... Ayi

1. Zithunzi

Mpanda	Dzenje lotaikira madzi	Buku la nsonkhansonkha
Kashi buku	Pulani ya mmene tisamalire Mjigo	Fomu ya mgwirizano
Zinthu zingawononge madzi	Zomwe	



Rural Water Supply Operation and Maintenance Series were developed for planners, managers and practitioners for the practices of operation and maintenance of boreholes fitted with Afridev hand pumps in rural Malawi.